



A37 Plastic Series- Plastic housing, PVC coated hose sheathing

Fits: 50 - 60 mm Objectives Mounting: 3 Thumb Screws Working Distance: 1.5in. - 9.0in.

Model	Part #	Cable Length (in.) "A"	End Tip Dia. (in.) "B"	Light Source Adapter for .590 (15mm) Input	Light Source Adapter for 1.00 (25mm) Input	Optional Polarizer
A3739M	002190120039	36	.588	Direct Fit	SX-13	 <p>A37P-PLZ 010090510000</p>
A3739P	002190040039	36	.562	N/A	SX-10	
A3748P	002190040048	45	.562	N/A	SX-10	
A3760P	002190040060	57	.562	N/A	SX-10	
A3775P	002190040075	72	.562	N/A	SX-10	
A3775M	002190120075	72	.588	Direct Fit	SX-13	
A3739B	002190070036	36	.588 with groove	Direct Fit	SX-13	

A37 Metal Series - High gloss anodized housing, stainless steel sheathing

Fits: 50- 58 mm Objectives Mounting: 3 Thumb Screws Working Distance: 1.5in. - 9.0in.

Model	Part #	Cable Length (in.) "A"	End Tip Dia. (in.) "B"	Light Source Adapter 1.00 (25mm) Input	Optional Polarizer
A3739	002190010039	36	.560	SX-10	N/A
A3775	002190010075	72	.560	SX-10	N/A

A3739P Dimensions:

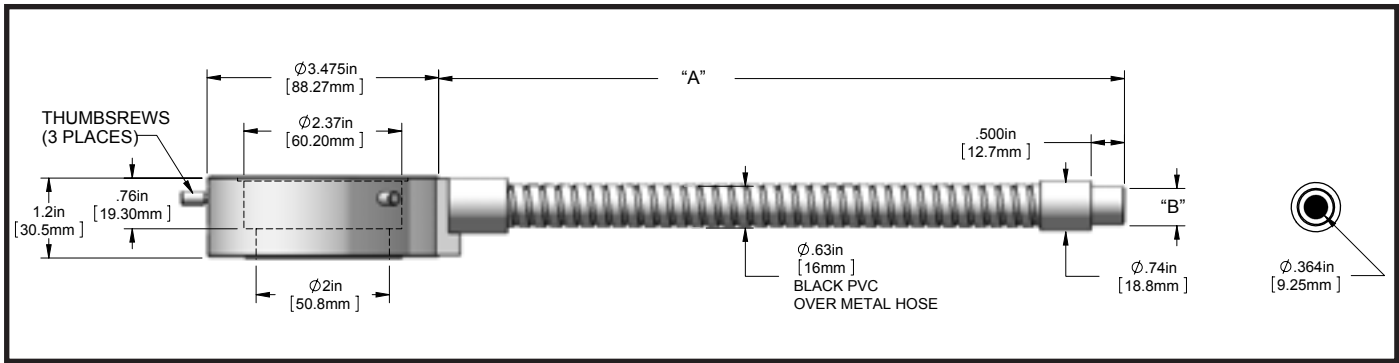

A3739M Dimensions:

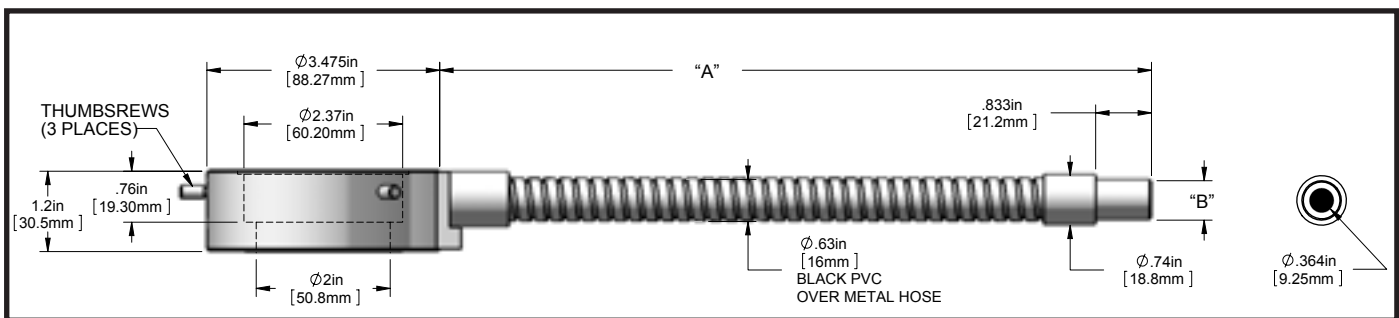

A3739 Dimensions:

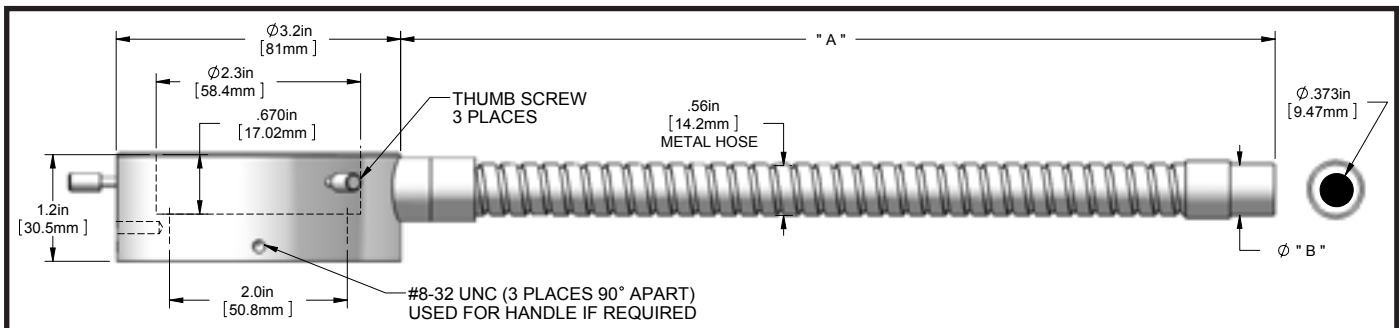

Note: Ring lights available in variety of lengths. 36 inch version shown in diagram above. Please contact Dolan-Jenner for availability on length variations. Please note two standard end ferrules available along with many custom designs.

Dolan-Jenner

industries

Dolan-Jenner Industries
159 Swanson Rd.
Dorchester, MA 01710 USA

Phone: 800.833.4237
Fax: 978.264.0292
Email: support@dolan-jenner.com

Vision Light Tech B.V.

Protonenlaan 22, 5405 NE UDEN, P.O. Box 345, 5400 AH UDEN, The Netherlands

Phone: +31 (0)413 26 00 67, Fax +31 (0)413 26 09 38, E-mail: inquiry@vlt.nl, Website: www.vlt.nl

Trade register No. 17150044, VAT No. NL8112.30.946.B01