

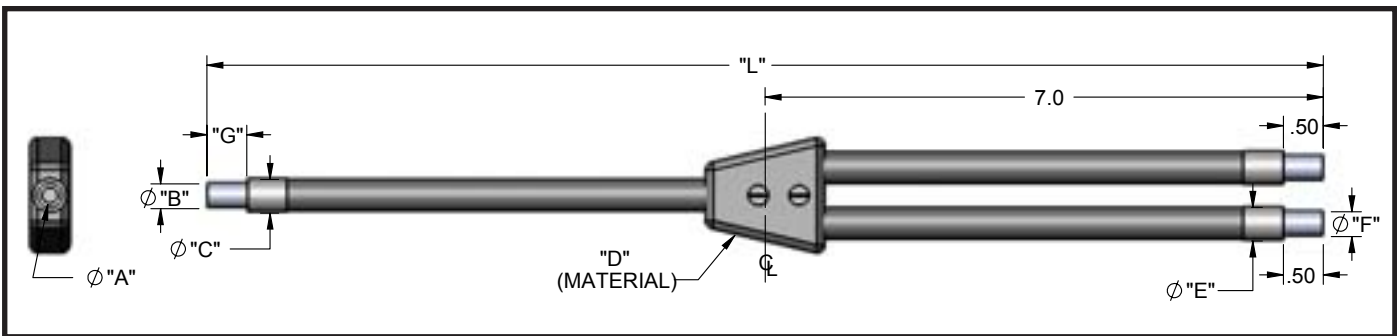

BXIUV - Standard End Ferrule, Stainless Steel Sheathing, Rated for -40°F to 347°F

Model	Part #	A	B	C	D	E	F	G	L
BXIUV6120	002014006120	.062" (1.59mm)	.187" (4.75mm)	.286" (7.23mm)	.203" (5.15 mm)	.286" (7.23mm)	.187" (4.75mm)	.50" (12.7mm)	24" (609.60 mm) 36" (914.40 mm)
BXIUV824	002014008024	.125" (3.18mm)	.187" (4.75mm)	.375" (9.52mm)	.345" (8.76mm)	.375" (9.52mm)	.187" (4.75mm)	.50" (12.7mm)	24" (609.60 mm)
BXIUV836	002014008036								36" (914.40 mm)
BXIUV860	002014008060								60" (1524.0 mm)
BXIUV884	002014008084								84" (2133.6 mm)
BXIUV424	002014004036	.250" (6.35mm)	.312" (7.92mm)	.615" (15.6mm)	.560" (14.22mm)	.615" (15.6mm)	.312" (7.92mm)	.50" (12.7mm)	24" (609.60 mm)
BXIUV436	002014004036								36" (914.40 mm)
BXIUV448	002014004048								48" (1219.2 mm)
BXIUV460	002014004060								60" (1524.0 mm)



EIUUV - Standard End Ferrule, PVC Monocoil Sheathing, Rated for -40°F to 221°F

Model	Part #	A	B	C	D	E	F	G	L
EIUUV624	002022006024	.062" (1.59mm)	.187" (4.75mm)	.253" (6.42mm)	PVC Heat Shrink	.205" (5.2mm)	.187" (4.75mm)	.50" (12.7mm)	24" (609.60 mm) 36" (914.40 mm)
EIUUV636	002022006036	.125" (3.18mm)	.187" (4.75mm)	.312" (7.92mm)	PVC Heat Shrink	.253" (6.42mm)	.187" (4.75mm)	.50" (12.7mm)	24" (609.60 mm)
EIUUV824	002022008024								36" (914.40 mm)
EIUUV424	002022004024								48" (1219.2 mm)
EIUUV436	002022004036								60" (1524.0 mm)
EIUUV448	002022004048	.250" (6.35mm)	.312" (7.92mm)	.468" (11.9mm)	PVC Heat Shrink	.422" (10.7mm)	.312" (7.92mm)	.50" (12.7mm)	24" (609.60 mm) 36" (914.40 mm) 48" (1219.2 mm)

Vision Light Tech B.V.

Protonenlaan 22, 5405 NE UDEN, P.O. Box 345, 5400 AH UDEN, The Netherlands

Phone: +31 (0)413 26 00 67, Fax +31 (0)413 26 09 38, E-mail: inquiry@vlt.nl, Website: www.vlt.nl

Trade register No. 17150044, VAT No. NL8112.30.946.B01