

Bar Light LDLB Series

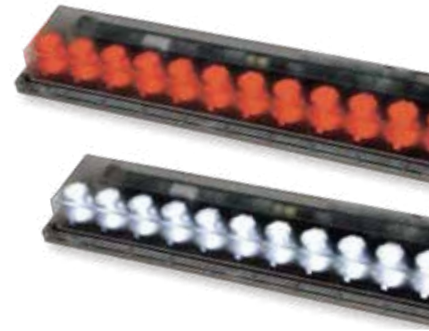

- Long-distance irradiation
- Switchable between overdrive lighting and constant lighting
- Built-in Controller
- Collective control of daisy-chain Lighting Units
- External light intensity control and ON/OFF control
- Waterproof model available



Application Examples

- Automotive: Checking for deposits of adhesive on door panels
- Packaging: Checking for cardboard inside beverage packages
- Traceability: Reading barcodes on a moving conveyor to verify products
- Shipping: Reading barcodes on pallets of bottles to verify the load count



Inspection for the existence of engine parts

Bright Bar Lights with Overdrive Li



500 mm

Features

▶ Long-distance irradiation

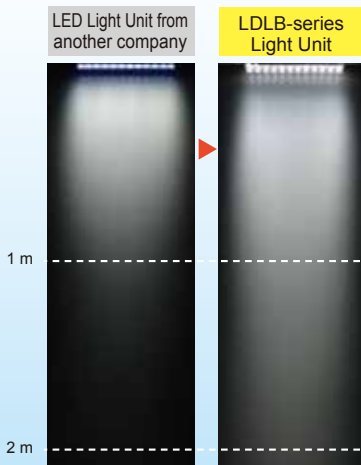

* Comparison with light intensity of 100% in constant lighting mode

Illuminance change graph

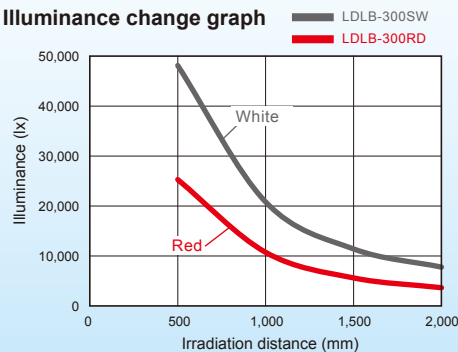

* Actual measured values at the center of the irradiated area by distance with a 100% light intensity. (This data is for reference only and does not guarantee product quality.)

▶ Overdrive lighting

Just one Lighting Unit provides both **constant lighting** and **overdrive lighting**.



* Operating time of the overdrive lighting depends on the light intensity. Refer to the Instruction Guide for details.

Select either a sinking (NPN) or sourcing (PNP) input for the control signals to matches your environment.

Applications

Inspections in pharmaceutical industry
Presence of tablets

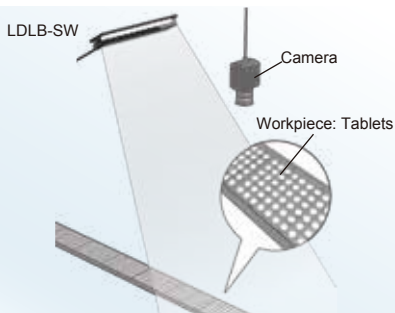

Inspections in packaging industry
Bottle cap appearance and tightening



Inspections in automotive industry

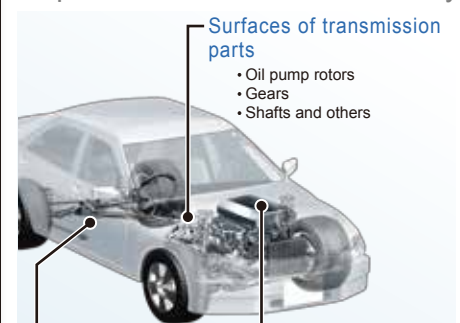

Presence of engine parts

- Mounting screws for head covers
- Oil caps
- Oil filters and others

Positions of holes on door parts

- Mounting holes for door locks
- Mounting holes for door knobs
- Mounting holes for side mirrors and others

Inspections in textile industry
Foreign matter and blots on and breaks in non-woven fabric

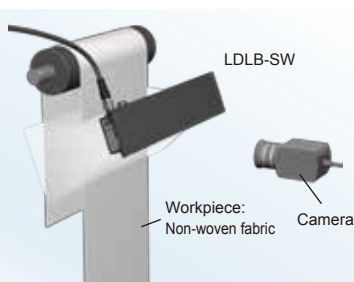

Inspections in foodstuff industry
Size of fruit

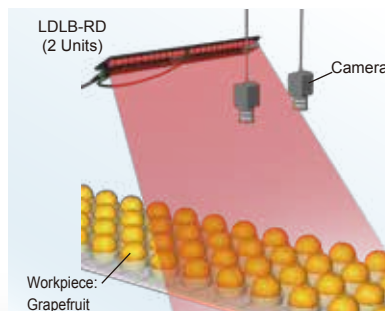

* The illustrations above are conceptual images.

Lighting to Handle Large Workpieces

1,000 mm

2,000 mm

Conceptual illustration

▶ Daisy-chain connections

You can daisy-chain up to three Light Units with a high degree of layout freedom.



▶ IP67-level waterproofing

A **waterproof model** is available that is ideal for production lines that are regularly cleaned.



LDLB-IP series

▶ Built-in Controller

You can easily operate the Light Unit from the control panel.

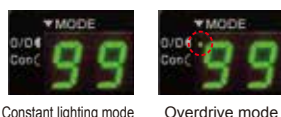

Constant lighting mode

Overdrive mode

Mode switching



Hold down two buttons to change the operating mode between constant lighting and overdrive lighting.

Light intensity setting



+: Increases the light intensity.
-: decreases the light intensity.
You can set the light intensity to any of 100 levels.

Data

LDLB-300SW (White)

Relative illuminance graph

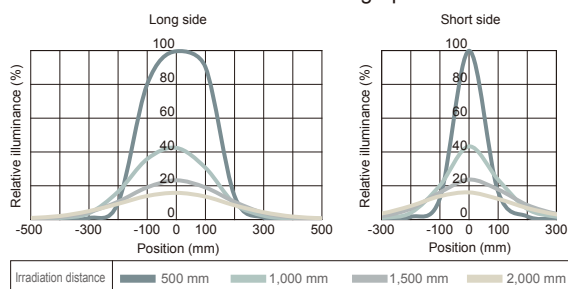

Uniformity graph (Relative irradiance)

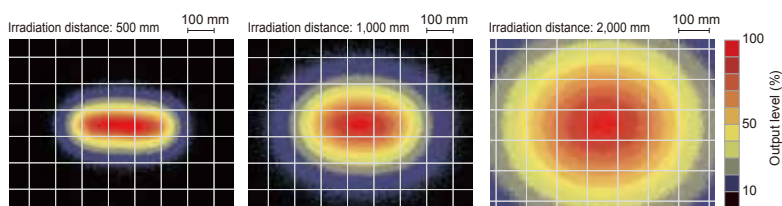

* This data is for reference only and does not guarantee product quality.

LDLB-300RD (Red)

Relative illuminance graph

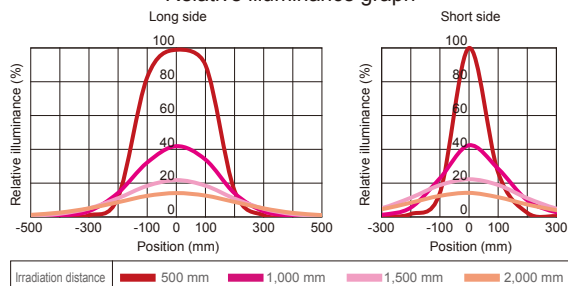

Uniformity graph (Relative irradiance)

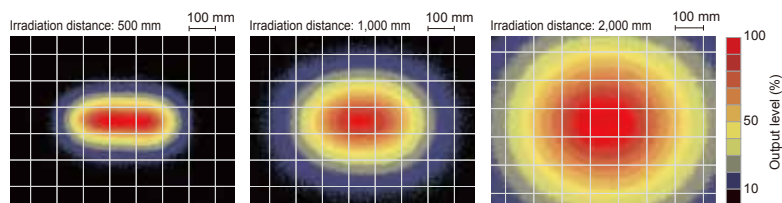

* This data is for reference only and does not guarantee product quality.

Common specifications

Series	LDLB series		LDLB-IP series (waterproof)		ON/OFF control	External signal input to turn ON the Light	Both sinking (NPN) and sourcing (PNP) input are available. You can switch the logic for turning the light ON and OFF.
Model name	LDLB-300SW-N	LDLB-300RD-N	LDLB-IP-300SW-N	LDLB-IP-300RD-N			
Protective structure	-		IP67 compliant (JIS C 0920)		Weight	500 g	
LED color	White	Red	White	Red	Accessories	Instruction Guide x1	
Correlated color temp. (typ.)	6,100 K	-	6,100 K	-	CE marking	Safety standard: Conforms to EN62471, EMS standard: Conforms to EN61000-6-2, EMI standard: Conforms to EN61000-6-4	
Peak wavelength	-	630 nm	-	630 nm	Environmental regulations	RoHS compliant	
Power consumption (max.)	31 W	24 W	31 W	24 W	Case material	Aluminum alloy, Resin	
Input voltage (rating)	24 VDC				Operating environment (indoors only)	Temperature: 0 to 40°C, Humidity: 20 to 85%RH (with no condensation)	
Input voltage (range)	22.8 to 26.4 VDC				Storage Environment	Temperature: -20 to 60°C, Humidity: 20 to 85%RH (with no condensation)	
Input current (rating)	Continuous mode: 1.3 A max., Overdrive mode: 6 A max.				Cooling method	Natural air cooling	
Input connector	M12 (5 pins, plug)				Light spectrum		
Output connector	M12 (5 pins, socket)						
Inrush current (max.)	6 A from a cold start						
Intensity control	Manual: Set any of 100 steps via the setting switch.						
	External: Analog voltage(0 V to +10 V)						

* This data is for reference only and does not guarantee product quality.

Dimensions (mm)

LDLB series

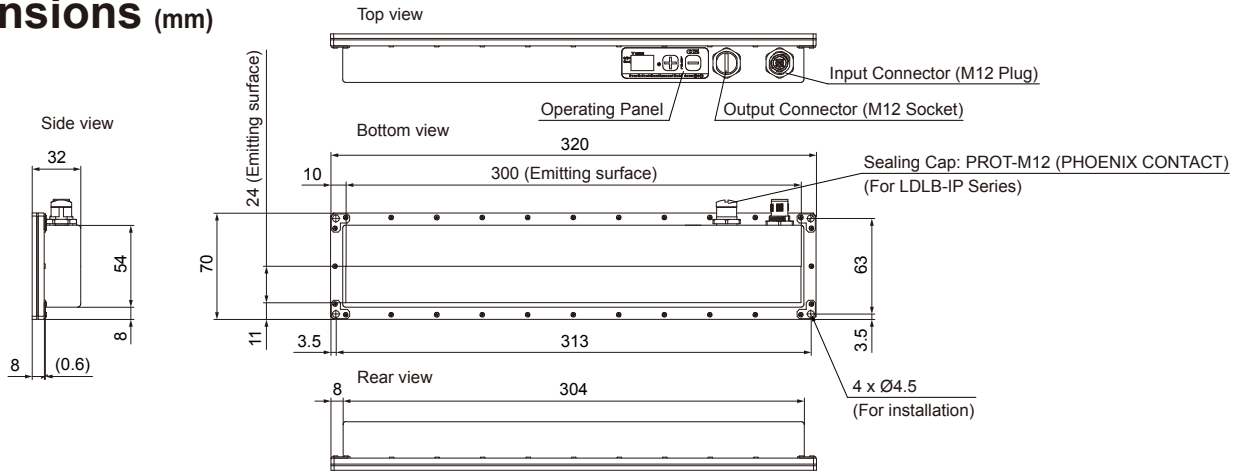

Options

Input cable

This cable supplies power to the Light Unit and inputs signals for light intensity control or to turn the light ON and OFF.

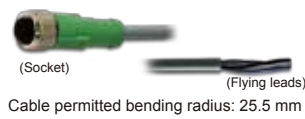

Model	FECB-1-M12-5F	FECB-2-M12-5F	FECB-3-M12-5F	FECB-5-M12-5F
Length	1 m	2 m	3 m	5 m
Weight	55 g max.	90 g max.	130 g max.	210 g max.

Link cable

This cable is used to daisy-chain Light Units.

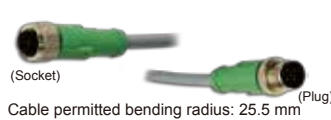

Model	FECB-0.6-M12-5M-5F
Length	0.6 m
Weight	50 g max.

System configuration example

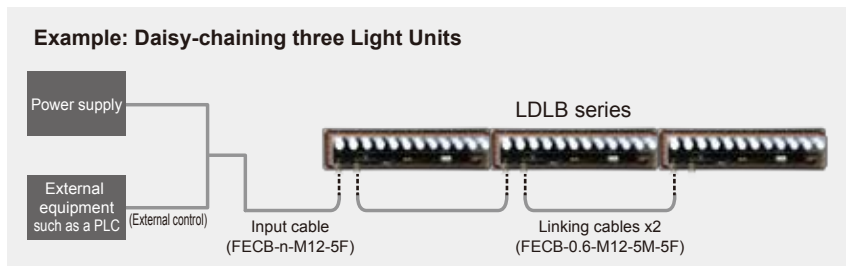

Maximum length of optional cables

	Number of Light Units connected in Constant Lighting Mode			Number of Light Units connected in Overdrive Mode		
	1	2	3	1	2	3
Number of Light Units	10 m	7 m	4.5 m	3 m	1 m	Cannot be used.
Number of Light Units	1	The table gives the maximum length of the Input Cable.				
	2 or 3	The table gives the maximum total length of the Input Cable and Link Cables.				

The wire diameter is AWG22 for the optional cables. If the maximum length given above is exceeded, shorten the Input Cable or contact CCS.

• "CCS", "LIGHTING SOLUTION", and "LDLB" are registered trademarks or trademarks of CCS Inc.

CAUTION

- To ensure proper and safe use of the product, please read the Instruction Guide completely before using the product.
- The design and specifications of this product are subject to change without notification for product improvement.
- The workpiece imaging examples included in this pamphlet are intended to serve only as references to help you select a suitable Light Unit. Please verify the functionality and conditions required for your particular application before you make a final selection. The sample workpieces used in this pamphlet have been processed specifically for sample imaging. They are not intended to represent product quality and performance.



Headquarters
Shimodachiuri-agaru, karasuma-dori, kamigyo-ku,
Kyoto 602-8011 JAPAN
TEL : +81-75-415-8284 / FAX : +81-75-415-8278
URL : <http://www.ccs-grp.com/>
E-mail : sales@ccs-inc.co.jp

CCS Asia PTE LTD
63 Hillview Avenue #07-10, Lam Soon Industrial
Building, Singapore 669569
TEL : +65-6769-1669 / FAX : +65-6769-3422
URL : <http://www.ccs-asia.com.sg/>
Email : sales@ccs-asia.com.sg

CCS America, Inc
5 Burlington Woods Suite 204 Burlington, MA 01803 USA
TEL : +1-781-272-6900 / FAX : +1-781-272-6902
URL : <http://www.ccsamerica.com/>
Email : info@ccsamerica.com

CCS Inc. Shanghai Office
Room 308B-309, CIMIC Tower No.1090 Century Avenue,
Pu Dong New Area, Shanghai 200120, P.R. China
TEL : +86-21-5835-8728 / FAX : +86-21-5835-8928
Email : ccschina@ccs-inc.co.jp

CCS Europe NV/SA
Bergensesteenweg 423, Bus 13
1600 Sint-Pieters-Leeuw, Belgium
TEL : +32-(0)2-333-0080 / FAX : +32-(0)2-333-0081
Email : info@ccseu.com

CCS Inc. Shenzhen office
17B, China Economic Trade Building, 7Rd Zizhu, Zhuzilin,
Futian District, Shenzhen 518040 P.R.China
TEL : +86-755-8279-0477 / FAX : +86-755-8279-0478
Email : ccschina@ccs-inc.co.jp