

1.5 MP 4/3" Fixed-Focal

# GMHR63520MCN

+31 (0)413 26 00 67

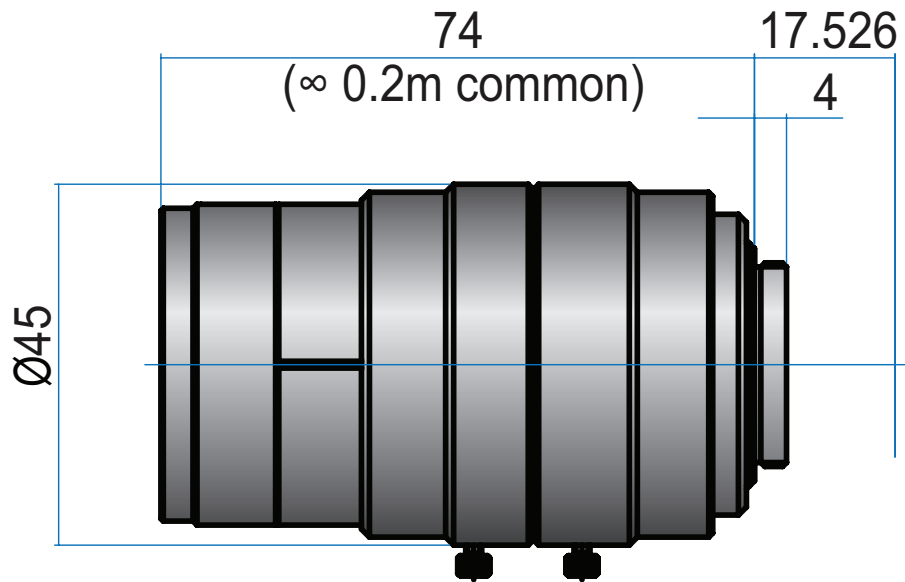

Part No.	GMHR63520MCN
Focal Length	35mm
Iris Range	f/2-16
Lens Format	4/3"
Resolution	120 lp/mm
MOD	200mm
Mount	C
Filter Thread	M37.5 x P0.5
Angle of View (HxVxD) 4/3"	29.6° x 22.4° x 36.6°
Weight	210g
Dimension (DxL)	Ø45 x 74