

Glass Fiber Optic Back Lights - Borosilicate core/Borosilicate clad

Spectral Curve of Glass Fibers

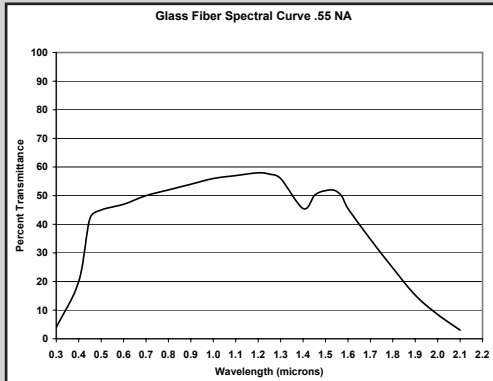

Fiber Specifications (Not Back Light Output)

Individual Fiber Diameter	0.002" (0.051 mm) Typical; 0.001" (0.025 mm) Available
Acceptance Cone	68.0°
Numerical Aperture	.55
Fiber Material	Core: Borosilicate Cladding: Borosilicate
Temperature capabilities	QVABL, QVMABL, 70000215 and QVABL22: -40°F to 220°F (-40°C to 107°C) QVMABLHT: -40°F to 400°F (-40°C to 205°C)
Spectral Transmittance	400nm-2000nm (.40-2.0 microns)
Minimum Bend Radius	1 ½" for 1/8" and 1/16" bundle diameter / 3" for ¼" bundle dia.
Maximum Breakage	2%
Housing Material	QVABL, QVABL22 & QVMABLHT: Anodized Black Aluminum QVMABL & 70000215: Black Nylatron
Diffuser Material	QVABL, QVMABL, QVABL22 & 70000215: Acrylic QVMABLHT: Glass

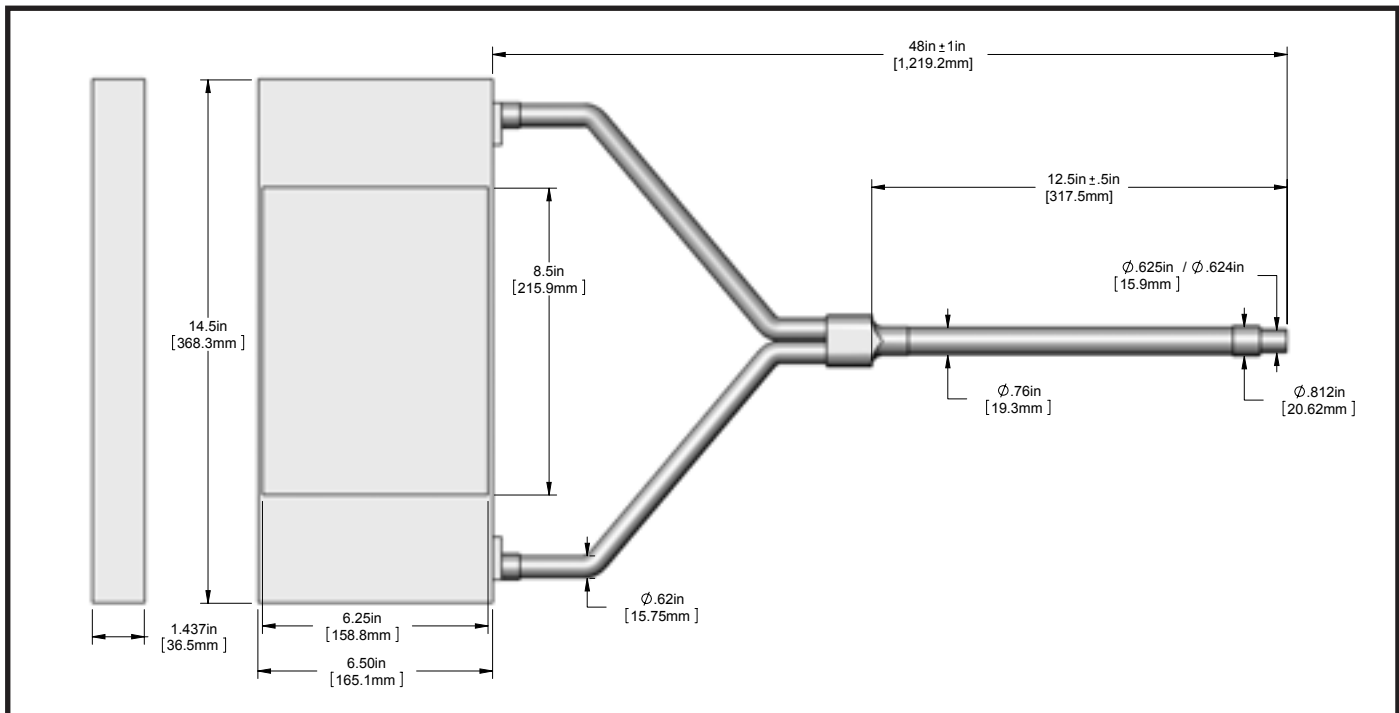

Large Area Back Light - Standard End Ferrule, PVC-Covered Metal Hose, Rated for -40°F to 175°F

Model	Part #	A	B	C	D	E	F	G	H	I	L
700002151048	700002151048	.553" (14.05mm)	.625" (15.9mm)	.906" (23mm)	.803" (20.4mm)	1.437" (36.5mm)	14.50" (368.3mm)	6.50" (165.1mm)	8.5" (215.9mm)	6.50" (165.1mm)	48" (1219.2 mm)

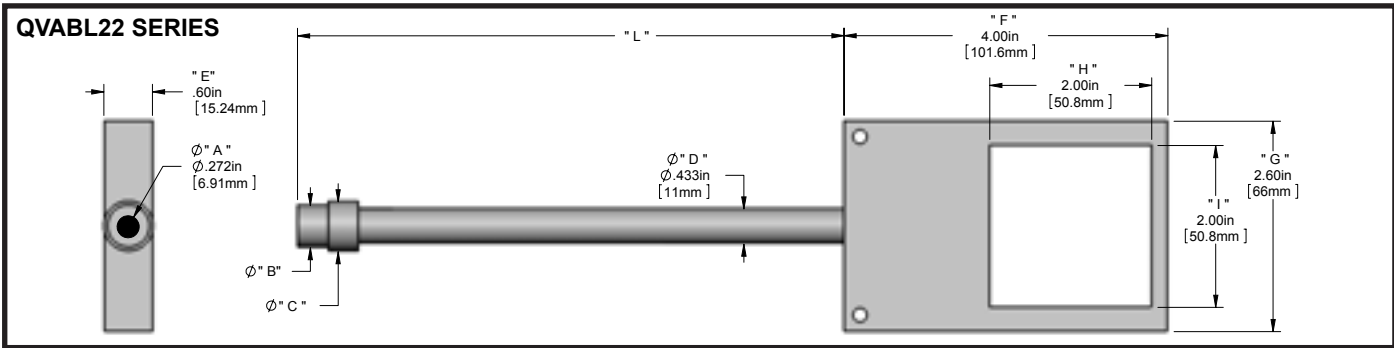
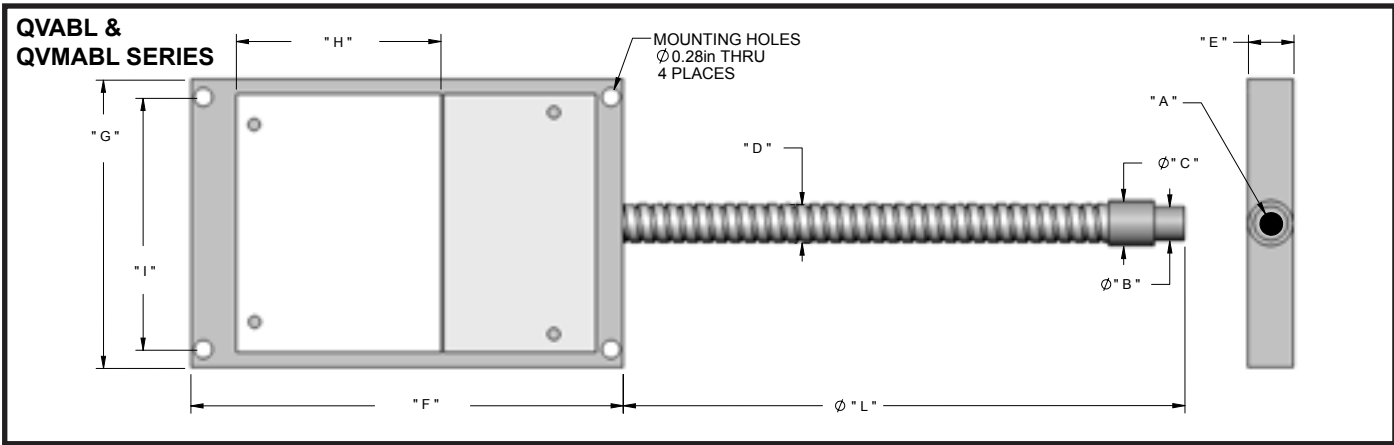

QVABL - Standard End Ferrule, PVC-Covered Metal Hose, Rated for -40°F to 175°F

Model	Part #	A	B	C	D	E	F	G	H	I	L
QVABL48	SK92630048										48" (1219.2 mm)
QVABL68	SK92630068	.365"	.560	.74"	.64"	.75"	7.12"	4.75"	3.37"	4.25"	68" (1727.2 mm)
QVABL72	SK92630072	(9.26mm)	(14.22mm)	(18.80mm)	(16.2mm)	(19.1mm)	(180.8mm)	(120.7mm)	(85.6mm)	(108mm)	72" (1828.8 mm)
QVABL108	SK92630108										108" (2743 mm)
QVABL36M	700008690036	.365"	.588	.74"	.64"	.75"	7.12"	4.75"	3.37"	4.25"	36" (914.40 mm)
QVABL48M	700008690048	(9.26mm)	(14.94mm)	(18.80mm)	(16.2mm)	(19.1mm)	(180.8mm)	(120.7mm)	(85.6mm)	(108mm)	48" (1219.2 mm)
QVABL2236	700010280036	.272"	.588"	.615"	.433"	.600"	4.00"	2.60"	2.00"	2.00"	36" (914.40 mm)
QVABL2248	700010280048	(6.91mm)	(14.94mm)	(15.62mm)	(11.00mm)	(15.24mm)	(101.6mm)	(66.0mm)	(50.8mm)	(50.8mm)	48" (1219.2 mm)
QVABL2272	700010280072										72" (1828.8 mm)

QVMABL - Standard End Ferrule, PVC Monocoil Sheathing, Rated for -40°F to 175°F

Model	Part #	A	B	C	D	E	F	G	H	I	L
QVMABL36	SK83560036										36" (914.40 mm)
QVMABL48	SK83560048										48" (1219.2 mm)
QVMABL72	SK83560072	.250"	.312"	.422"	.40"	.630"	3.375"	2.05"	1.63"	1.86"	72" (1828.8 mm)
QVMABL79	SK83560079	(6.35mm)	(7.92mm)	(10.72mm)	(10.16mm)	(16.0mm)	(85.7mm)	(52.1mm)	(413mm)	(47.2mm)	79" (2006.6 mm)
QVMABL96	SK83560096										96" (2438.4 mm)
QVMABL100	SK83560100										100" (2540.0 mm)
QVMABL120	SK83560120										120" (3048.0mm)
QVMABL36M	002400050036	.250"	.588	.615"	.40"	.630"	3.375"	2.05"	1.63"	1.86"	36" (914.40 mm)
QVMABL48M	002400050048	(6.35mm)	(14.94mm)	(15.62mm)	(10.16mm)	(16.0mm)	(85.7mm)	(52.1mm)	(413mm)	(47.2mm)	48" (1219.2 mm)

QVMABLHT - Standard End Ferrule, Stainless Steel Sheathing, Rated for -40°F to 400°F

Model	Part #	A	B	C	D	E	F	G	H	I	L
QVMABLHT	700000560048	.250"	.312"	.500"	.422"	.630"	3.375"	2.05"	1.63"	1.86"	48" (1219.2 mm)
		(6.35mm)	(7.92mm)	(12.7mm)	(10.72mm)	(16.0mm)	(85.7mm)	(52.1mm)	(413mm)	(47.2mm)	

Vision Light Tech B.V.

Protonenlaan 22, 5405 NE UDEN, P.O. Box 345, 5400 AH UDEN, The Netherlands

Phone: +31 (0)413 26 00 67, Fax +31 (0)413 26 09 38, E-mail: inquiry@vlt.nl, Website: www.vlt.nl

Trade register No. 17150044, VAT No. NL8112.30.946.B01