

Oblique Angled Lights for Line Sensor

LNIS/LNIS-FN Series

LNIS series

LNIS-FN series

**Streak Inspection
Best for Finding
Moving-direction Scratches**

Applications

Visual inspection

- 1) Streak inspection on sheets
- 2) Scratch inspection on transparent film
- 3) Scratch inspection on plate glass
- 4) Scratch inspection on sheet metal

Bi-directional angled light with unique light-focusing technology

Best for finding moving-direction scratches

Crossing angled lighting



Conventional lighting



● Imaging example

■ Imaging moving-direction scratches on a film

LNIS series

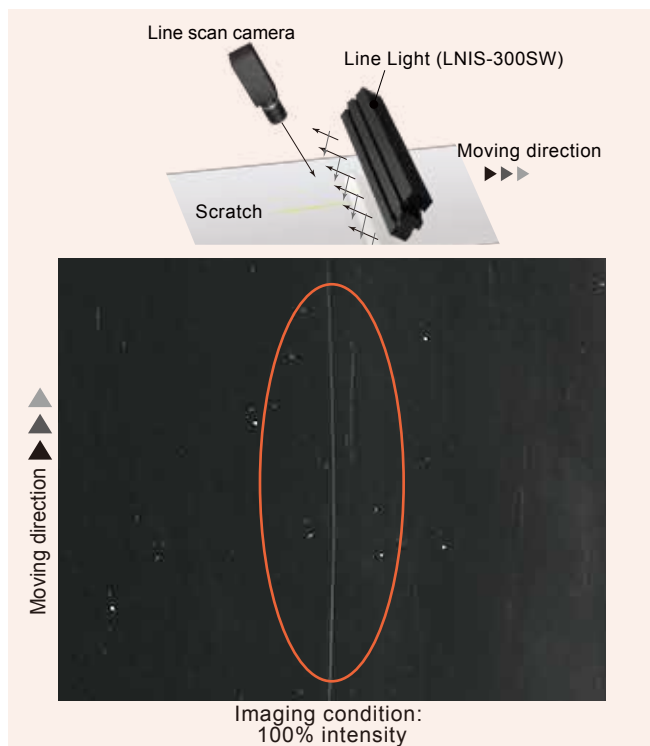

Only a scratch is selectively highlighted. Brightness and noises of the background do not increase even in the high intensity.

Conventional light-focusing Line Light: LNPS series

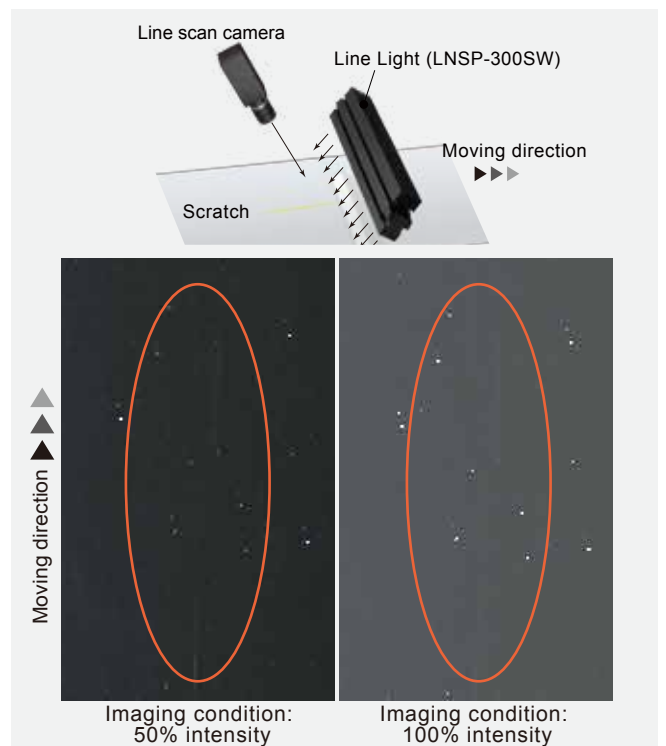

It is hard to highlight only a scratch with ordinary lighting. Brightness and noises of the background increase in the high intensity, so that a contrast ratio is not enhanced.



Finding moving-direction scratches

Designed for detecting moving-direction scratches

Under a brand-new concept, the main purpose of the LNIS series is to find moving-direction scratches, which are difficult to find using conventional Line Lights.

For higher intensity, CCS provides the LNIS-FN series to meet more applications.

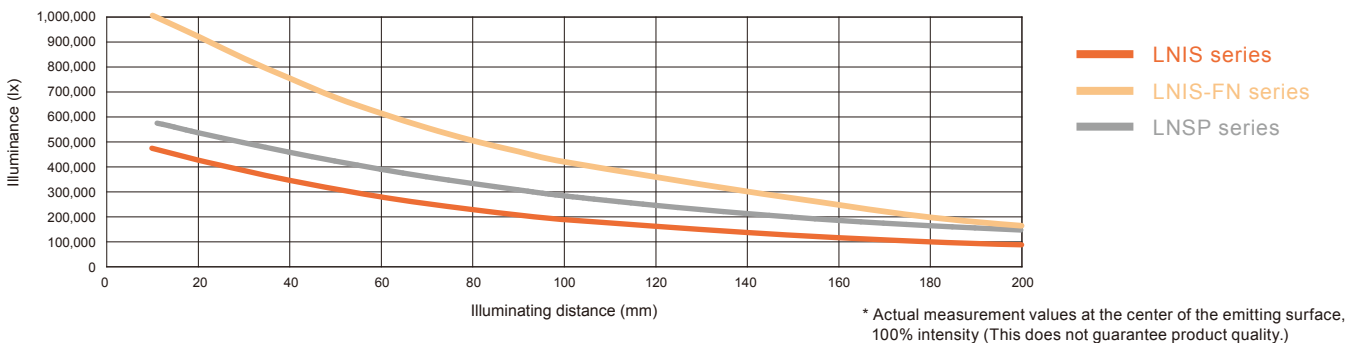

Characteristics

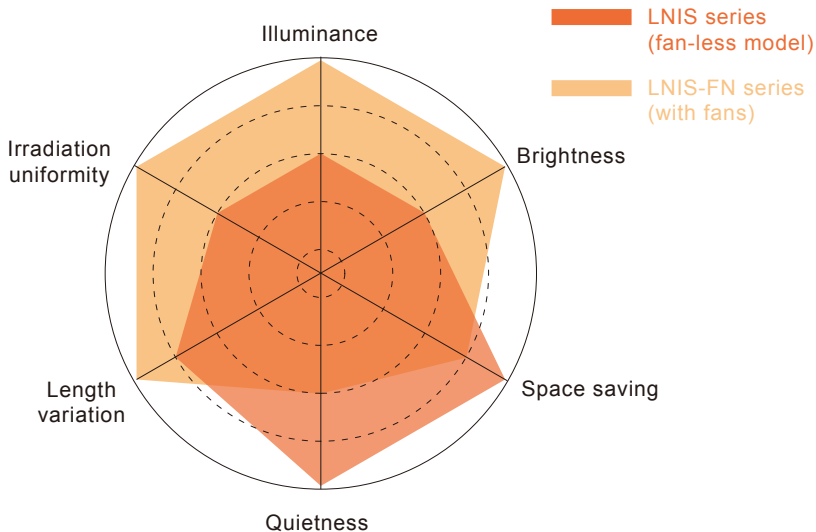

The LNIS series are:

- 1) Fan-less (natural air-cooling)
- 2) Space-saving
- 3) 1,000 mm max. in length (standard products)
- 4) Driven by the constant-voltage system

If you need higher intensity, use the LNIS-FN series which are equipped with cooling fans.

The LNIS-FN series support more than 1,000 mm length with standard product. Uniformity of the emitting surface is good due to the constant-current driven system.

Series	Illuminance
LNIS-FN series	678,000 lx LWD = 50 mm
LNIS series	310,000 lx LWD = 50 mm

Length variation

LNIS



Fan-less model

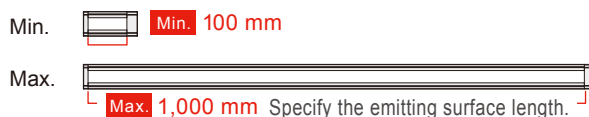

LNIS-FN



With fans



Select the emitting surface length from 100 to 1,500 mm with a 100 mm pitch. (1,000 mm max. for the LNIS series) Please contact your CCS sales representative for details.

* You may find a joint portion of the optical component on the emitting surface whose length is 1,300 mm and more. However, there is no problem for use in dark-field imaging.

Conceptual image of the irradiation

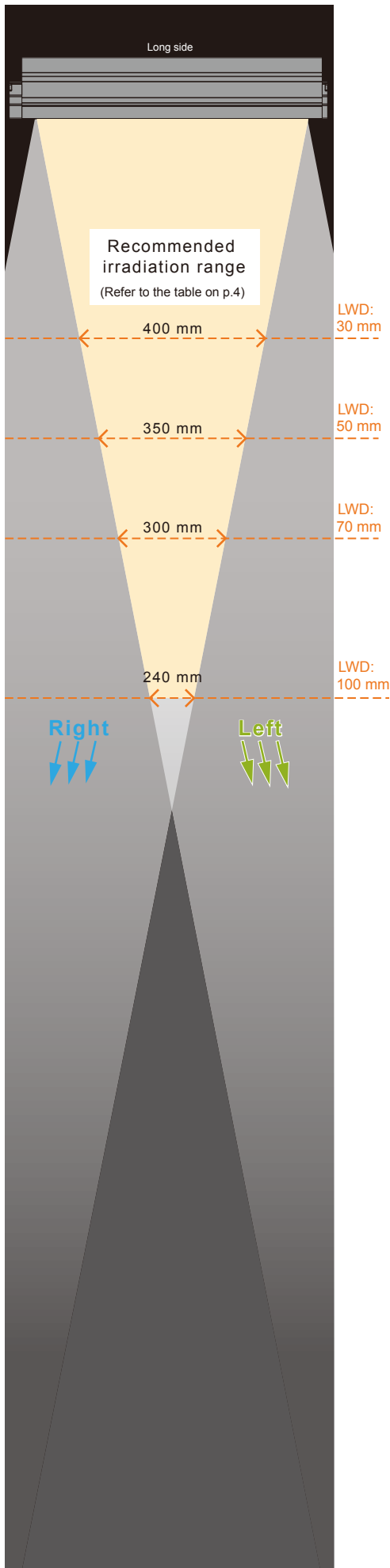

* LWD is the distance from the Line Light to the workpiece.

Example: LNIS-500SW



Fan-less
(Natural air-cooling)
500 mm
White

Direction of measurement

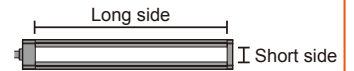

Graph of effective illumination range

Illuminating distance: 30 mm

* The values are based on the simulation. This does not guarantee product quality.

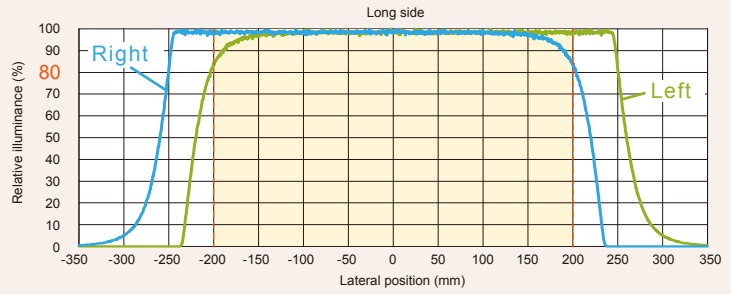

Illuminating distance: 50 mm

* The values are based on the simulation. This does not guarantee product quality.

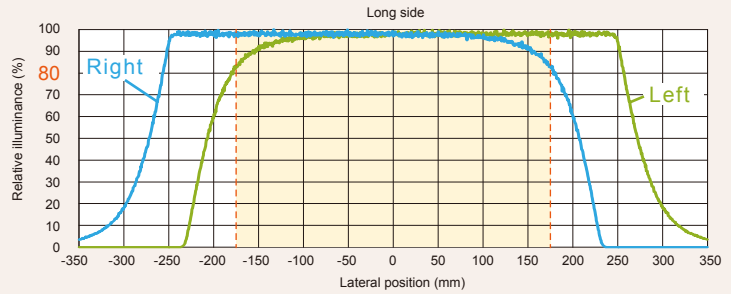

Illuminating distance: 70 mm

* The values are based on the simulation. This does not guarantee product quality.

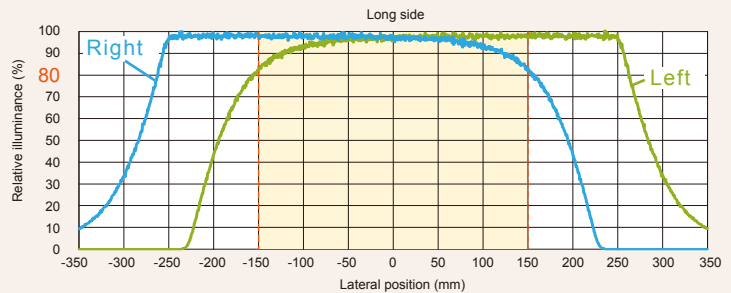

Illuminating distance: 100 mm

* The values are based on the simulation. This does not guarantee product quality.

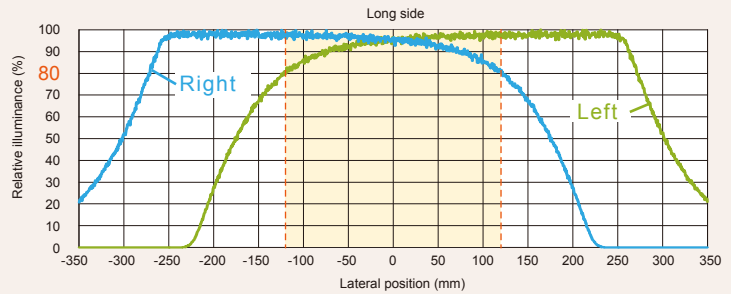

The section on the graph where "Left" and "Right" overlap is the section where light from the left and right sides overlaps. The recommended illumination range is the range in this overlapping section where each illuminance is ensured for 80% or higher of the peak.

* These graphs are for reference only and do not guarantee product quality.

Graph of the change in illuminance

Light Unit used: LNIS-500SW, LNIS-400SW-FN
 * Actual measurement values at the center of the emitting surface, 100% intensity
 (This does not guarantee product quality.)

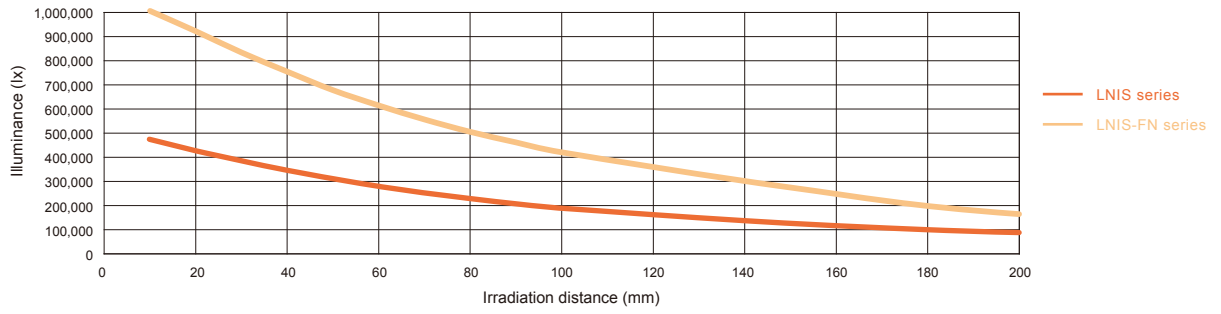

Characteristics of the irradiation distribution

Light Unit used: LNIS-400SW
 * This graph is for reference only and does not guarantee product quality.

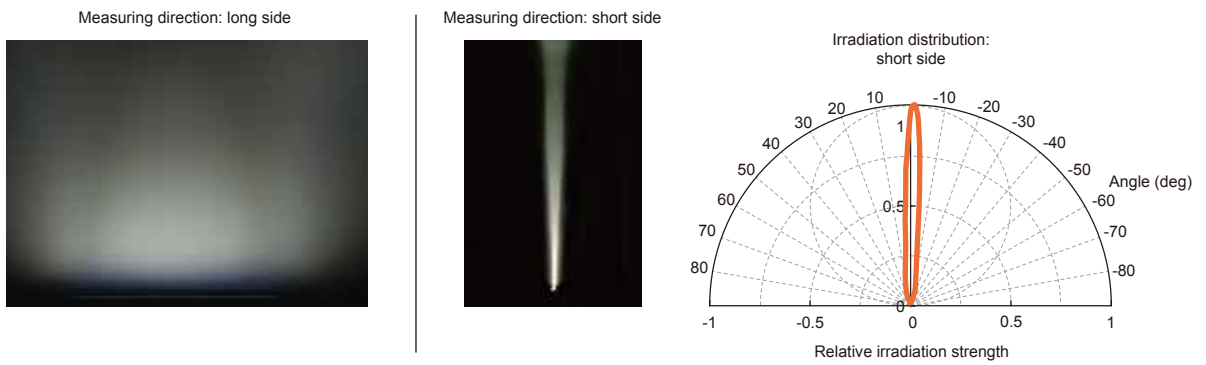

Graph of the correlation between intensity and light output

LNIS series

Light output characteristics of each intensity range when using Analog Control Unit (constant voltage) PSB3-30024

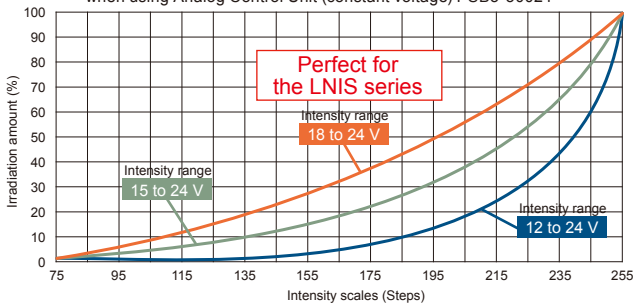

Light Unit used: LNIS-500SW
 * Actual measurement values when using Analog Control Unit PSB3-30024
 (This does not guarantee product quality.)

LNIS-FN series

Light output characteristics when using Analog Control Unit (constant current) PSCC-60048

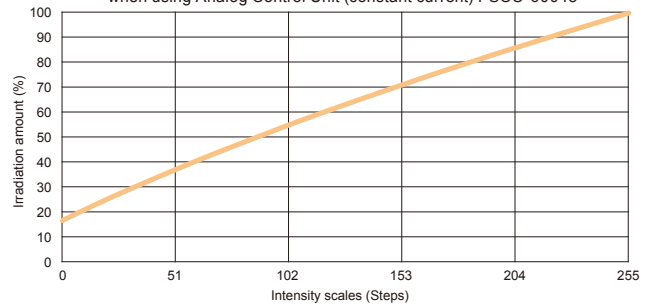

Light Unit used: LNIS-1500SW-FN
 * Actual measurement values when using Analog Control Unit PSCC-60048
 (This does not guarantee product quality.)

Table of the recommended irradiation range (Where illuminance of the left/right beam is 80% of the peak value or more.)

(mm)

LWD \ Emitting surface length	LNIS/LNIS-FN series										LNIS-FN series				
	100	200	300	400	500	600	700	800	900	1,000	1,100	1,200	1,300	1,400	1,500
10	40	140	240	340	440	540	640	740	840	940	1,040	1,140	1,240	1,340	1,440
30		100	200	300	400	500	600	700	800	900	1,000	1,100	1,200	1,300	1,400
50		50	150	250	350	450	550	650	750	850	950	1,050	1,150	1,250	1,350
70			100	200	300	400	500	600	700	800	900	1,000	1,100	1,200	1,300
100			40	140	240	340	440	540	640	740	840	940	1,040	1,140	1,240

* The values are based on the simulation. Actual range of the effective irradiation depends on your imaging environment.
 * LWD is the distance from the Line Light to the workpiece.

LNIS series

Fan-less (Natural air-cooling)

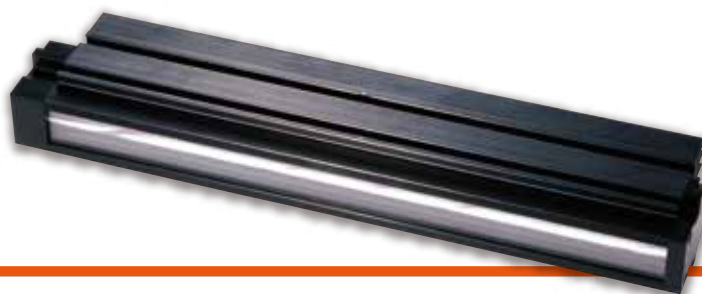

Specifications

LED color	White
Correlated color temperature	5,800 K (typ.)
Case material	Aluminum alloy, Resin
Cable length	300 mm
Connector	Metal connector SRCN1A16-7P (JAE)
Operating environment	0 to 40°C, Humidity: 20 to 85%RH (with no condensation)
Storage environment	-20 to 60°C, Humidity: 20 to 85%RH (with no condensation)
CE marking	Safety standard: EN 62471 compliant
Environmental regulations	RoHS compliant
Cooling method	Natural air-cooling
Light spectrum	

Model	A: Emitting surface (mm)	B: Total length (mm)	Power consumption (W)	Weight (g) (max.)
LNIS-100SW	100	126	21	430
LNIS-200SW	200	226	41	760
LNIS-300SW	300	326	61	1,090
LNIS-400SW	400	426	81	1,420
LNIS-500SW	500	526	101	1,740
LNIS-600SW	600	626	121	2,070
LNIS-700SW	700	726	142	2,400
LNIS-800SW	800	826	162	2,730
LNIS-900SW	900	926	182	3,050
LNIS-1000SW	1,000	1,026	202	3,380

Dimensions (mm)

LNIS-□□□SW

□□□: Emitting surface length

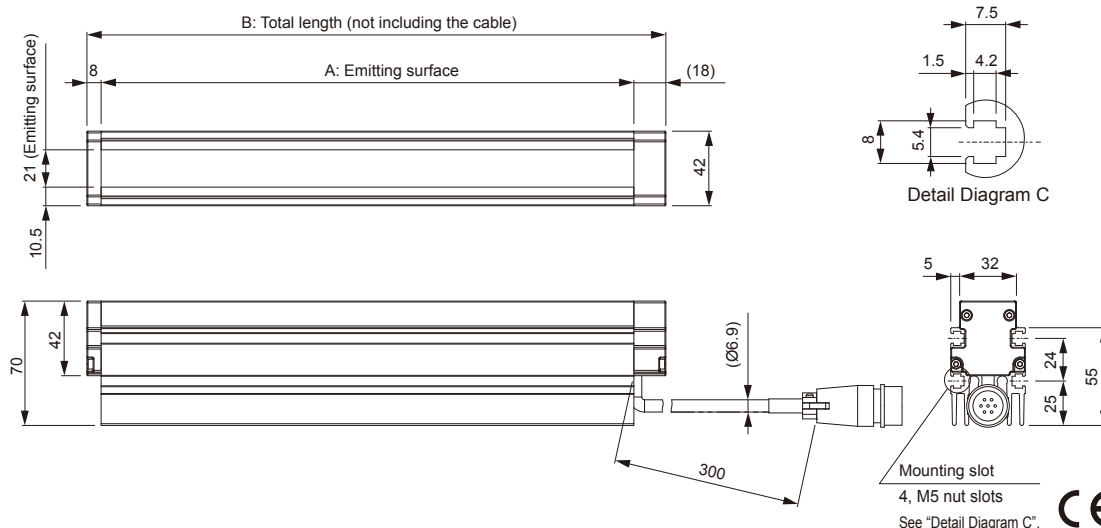

Options

Light Unit cables

These cables are used to connect the Light Unit and the Control Unit. You can choose from 2 m, 3 m, 5 m, 10 m, and 20 m.

Model	FCB-2-1.25SQ-ME7	FCB-3-1.25SQ-ME7	FCB-5-1.25SQ-ME7	FCB-10-1.25SQ-ME7	FCB-20-2.0SQ-ME7
Cable length	2 m	3 m	5 m	10 m	20 m
Weight	430 g	580 g	1,000 g	2,000 g	5,000 g

Dimensions (mm)

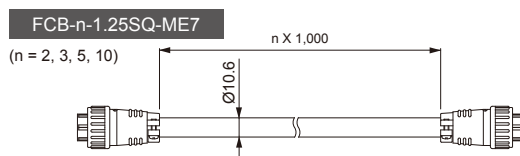

Cable permitted bending radius: 63.6 mm

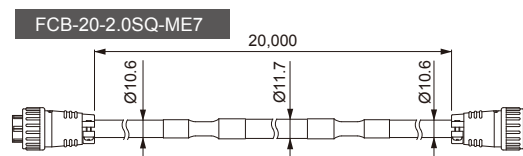

Cable permitted bending radius: 63.6 mm

LNIS-FN series

With fans



Specifications

LED color	White
Correlated color temperature	5,800 K (typ.)
Case material	Aluminum alloy, Steel sheet, Resin
Cable length	300 mm
Connector	Metal connector (PRC04-12A26S-37M18)
Operating environment	0 to 40°C, Humidity: 20 to 85%RH (with no condensation)
Storage environment	-20 to 60°C, Humidity: 20 to 85%RH (with no condensation)
CE marking	Safety standard: EN 62471 compliant EMC standard: Conforms to EN61000-6-2, EN61000-6-4
Environmental regulations	RoHS compliant
Cooling method	Forced air-cooling
Accessories	Frame nuts (four for emitting surface length up to 1,000 mm, seven for emitting surface length over 1,100 mm), FG line (2 m) x1, M3 Mounting screw x1
Light spectrum	

Model	A: Emitting surface (mm)	B: Total length (mm)	Power consumption (W) (including fans)	Weight (g max.)	Number of cooling fan
LNIS-100SW-FN	100	144	41	900	1
LNIS-200SW-FN	200	244	81	1,400	2
LNIS-300SW-FN	300	344	117	1,900	3
LNIS-400SW-FN	400	444	157	2,400	4
LNIS-500SW-FN	500	544	192	2,900	5
LNIS-600SW-FN	600	644	233	3,400	6
LNIS-700SW-FN	700	744	268	3,900	7
LNIS-800SW-FN	800	844	309	4,400	8
LNIS-900SW-FN	900	944	345	4,900	9
LNIS-1000SW-FN	1,000	1,044	384	5,500	10
LNIS-1100SW-FN	1,100	1,144	425	6,000	11
LNIS-1200SW-FN	1,200	1,244	460	6,500	12
LNIS-1300SW-FN	1,300	1,344	501	7,000	13
LNIS-1400SW-FN	1,400	1,444	536	7,500	14
LNIS-1500SW-FN	1,500	1,544	576	8,000	15

Dimensions (mm)

LNIS-□□□SW-FN

□□□: Emitting surface length

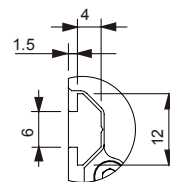
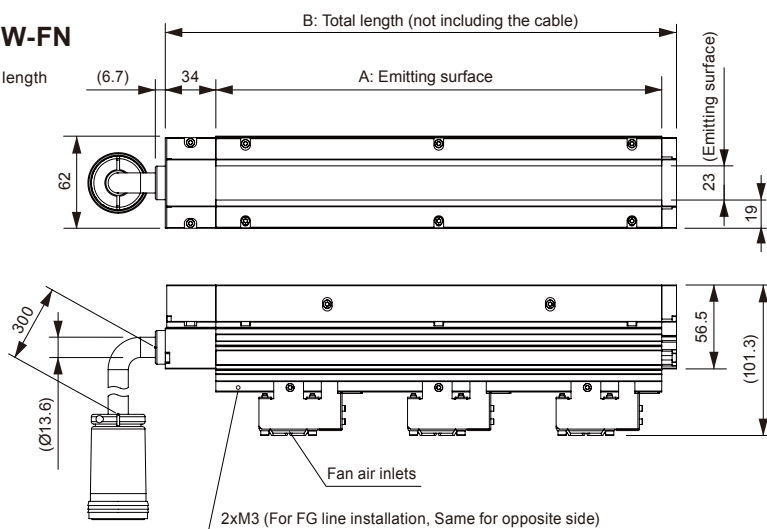

Detail Diagram C

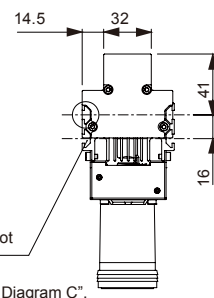

Mounting slot
4, nut slots
See "Detail Diagram C".



Options

Light Unit cables

These cables are used to connect the Light Unit and the Control Unit. Use the cable that is suitable for your installation site.

Model	QCBM-2	QCBM-3	QCBM-5	QCBM-10	QCBM-20
Cable length	2 m	3 m	5 m	10 m	20 m
Weight	800 g	1,000 g	1,500 g	2,700 g	5,000 g

Model	QCB-2	QCB-3	QCB-5	QCB-10	QCB-20
Cable length	2 m	3 m	5 m	10 m	20 m
Weight	1,100 g	1,500 g	2,400 g	4,600 g	8,900 g

Dimensions (mm)

(n = 2, 3, 5, 10, 20)

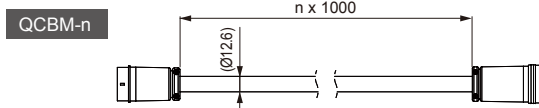

Applicable Control Unit: PSCC-30048

Cable permitted bending radius: 75.6 mm

(n = 2, 3, 5, 10, 20)

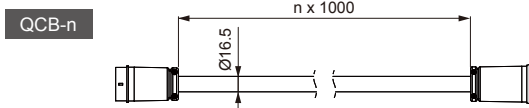

Applicable Control Unit: PSCC-60048

Cable permitted bending radius: 99 mm

Applicable Analog Control Unit for the LNIS series

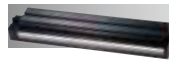

Refer to our website for product details.

CCS PSB3-30024



You can also use your smartphone or cell phone.

Use a search engine.

PSB3-30024

[300 W capacity]



CE

Characteristics

Constant-voltage system

Variable voltage control

1 channel

- Light output is 1 channel with 4 connectors (Metal connectors x 2, EL connectors x 2).
- Equipped for parallel, serial, and analog external control all in a single Unit.
- Select the appropriate voltage range for the Light Unit with Light intensity range selector to set the optimum intensity.

Dimensions (mm)

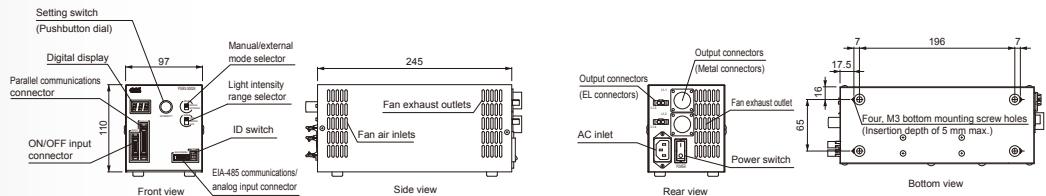

Applicable Analog Control Unit for the LNIS-FN series



Refer to our website for product details.

CCS PSCC



You can also use your smartphone or cell phone.

Use a search engine.

Characteristics

Constant-current system

Variable current control

1 channel

- Intensity control is performed by varying the current.
- Equipped for parallel, EIA-485, and Ethernet communications external control all in a single Unit.
- Error detection function notifies insufficient speed or stoppage of the cooling fans in the Light Unit, and also notifies LED burnout errors due to an open or shorted LED circuit.

PSCC-30048 [300 W capacity]

Dimensions (mm)

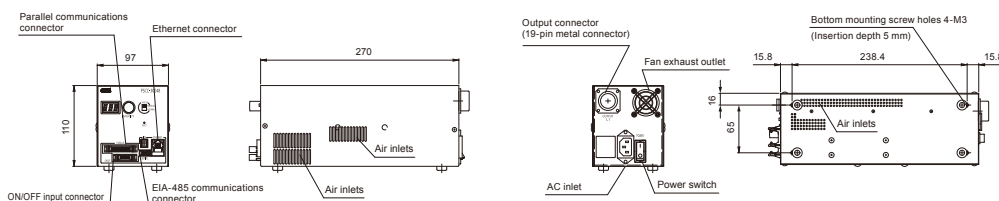

CE

PSCC-60048 [600 W capacity]

Dimensions (mm)

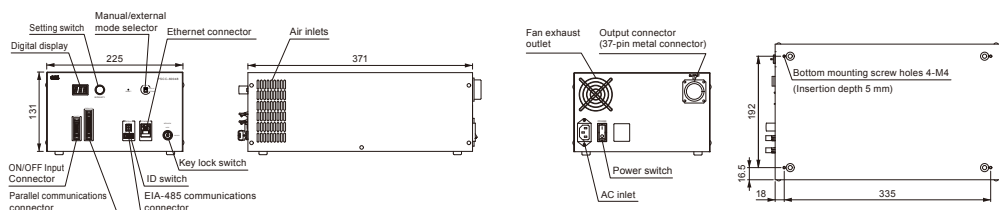

CE

● "CCS", "LIGHTING SOLUTION", "LNIS", "LNIS-FN", "PSB", and "PSCC" are registered trademarks or trademarks of CCS Inc.

CAUTION

- To ensure proper and safe use of the product, please read the Instruction Guide completely before using the product.
- The design and specifications of this product are subject to change without notification for product improvement.
- The workpiece imaging examples included in this pamphlet are intended to serve only as references to help you select a suitable Light Unit. Please verify the functionality and conditions required for your particular application before you make a final selection. The sample workpieces used in this pamphlet have been processed specifically for sample imaging. They are not intended to represent product quality and performance.

CCS Inc.

Headquarters
Shimodachiuri-agaru, karasuma-dori, kamigyo-ku,
Kyoto 602-8011 JAPAN
TEL : +81-75-415-8284 / FAX : +81-75-415-8278
URL : <http://www.ccs-grp.com/>
E-mail : sales@ccs-inc.co.jp

CCS Asia PTE LTD
63 Hillview Avenue #07-10, Lam Soon Industrial
Building, Singapore 669569
TEL : +65-6769-1669 / FAX : +65-6769-3422
URL : <http://www.ccs-asia.com.sg/>
E-mail : sales@ccs-asia.com.sg

CCS America, Inc
5 Burlington Woods Suite 204 Burlington, MA 01803 USA
TEL : +1-781-272-6900 / FAX : +1-781-272-6902
URL : <http://www.ccsamerica.com/>
Email : info@ccsamerica.com

CCS Inc. Shanghai Office
Room 308B-309, CIMIC Tower No.1090 Century Avenue,
Pu Dong New Area, Shanghai 200120, P.R. China
TEL : +86-21-5835-8728 / FAX : +86-21-5835-8928
Email : ccschina@ccs-inc.co.jp

CCS Europe NV/SA
Bergensesteenweg 423, Bus 13
1600 Sint-Pieters-Leeuw, Belgium
TEL : +32-(0)2-333-0080 / FAX : +32-(0)2-333-0081
Email : info@ccseu.com

CCS Inc. Shenzhen office
17B, China Economic Trade Building, 7Rd Zizhu, Zhuzilin,
Futian District, Shenzhen 518040 P.R.China
TEL : +86-755-8279-0477 / FAX : +86-755-8279-0478
Email : ccschina@ccs-inc.co.jp