

Europe / Middle East / Africa

FUJIFILM Europe GmbH
Heesenstr. 31, 40549 Duesseldorf, Germany
TEL: +49 (0) 211 5089 0 FAX: +49 (0) 211 5089 8900
<http://www.fujifilm.eu>
E-mail: cctv@fujifilm.eu

FUJIFILM France S.A.S.
16 Rue Etienne Jules Marey - BP 34
78391 BOIS D'ARCY Cedex - France
TEL: +33 (0)1-3014-3456 FAX: +33 (0)1-3460-1660
<http://www.fujifilm.eu>
E-mail: webmaster@fujifilm.fr

Fujifilm Russia
1st Magistralny tup., 5a, business center Magistral Plaza,
4th floor, 123290, Moscow, Russia
TEL: +7 (495)797-35-12 FAX: +7 (495)797-35-13
<http://www.fujifilm.eu>
E-mail: cctv@fujifilm.eu

Japan / North East Asia
FUJIFILM Corporation
Optical Device & Electronic Imaging Products Div.
1-324 Uetake, Kita-ku, Saitama City Saitama, 331-9624,
Japan
TEL: +81 (0)48-668-2152 FAX: +81 (0)48-651-8517
<http://www.fujifilm.co.jp/>

China

FUJIFILM (China) Investment Co., Ltd.
Optical Device Business Division
28F, Shanghai ONELUJIAZUI, No.68 YinCheng Road(M),
Pudong New Area, Shanghai, P.R.China 200120
TEL: +86-21-5010-6000 *384
FAX: +86-21-5010-6730
<http://www.fujifilm.com.cn>

Hong Kong / Taiwan

FUJIFILM Hong Kong Limited
Optical Device Division
Unit 1001-1007, 10/F., Metroplaza Tower 2,
223 Hing Fong Road, Kwai Fong, N.T., Hong Kong.
Tel: (852) 2376-0998 Fax: (852) 2724-1118

Southeast Asia & West Asia

Fujifilm Asia Pacific Pte Ltd.
10 New Industrial Road, Fujifilm Building Singapore 536201
TEL: +65 (0)63839933 FAX: +65 (0)63835666
<http://www.fujifilm.com.sg/>

Oceania

FUJIFILM Australia Pty Ltd.
114 Old Pittwater Road, Brookvale, N.S.W. 2100, Australia
TEL: +61 (0)2-9466-2600 FAX: +61 (0)2-9905-3801
<http://www.fujifilm.com.au/>

North & Latin America

FUJIFILM North America Corporation
Optical Devices Division
10 High Point Drive, Wayne, NJ 07470
TEL: +1-973-633-5600 FAX: +1-973-633-5216
<http://www.fujifilmusa.com>



FUJINON

Machine Vision Lenses

Authorized Fujifilm Service Agent.



Due to a continuous process of product improvement, design and specifications are subject to change without notice.
All photos, illustrations, drawings and other images in this brochure are intended for illustrative purpose only.





Be certain to read the instructions for use before using any equipment.

FFBX2016 04.



Contents

	PAGE		PAGE
■ HF-12M series 12MP, 2/3" 	4	■ TF series 3CCD, 1/3"	12
■ HF-XA series 3MP, 2/3" 	7	Technologies of "4D High Resolution"	6
■ HF-HA series 1.5MP, 2/3"	8	Magnification Ration Chart	13
■ HF-SA series 5MP, 2/3"	10	Technical Information	18
■ CF-HA series 1.5MP, 1"	11		

Lens Selection Guide

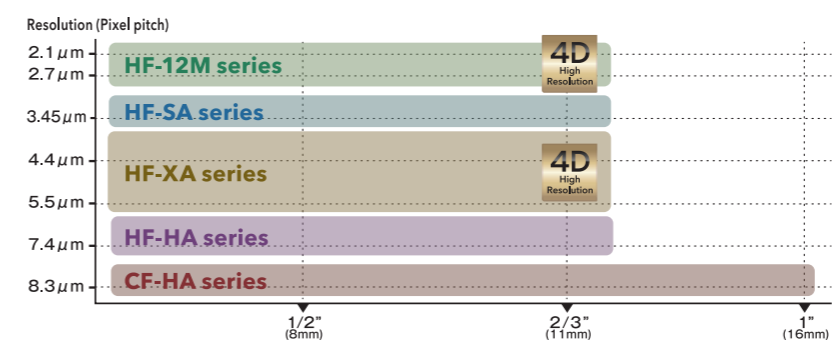

4D High Resolution

The "4D High Resolution" is the FUJINON lenses' unique performance. It maintains a high level of consistent image sharpness at the center as well as around the edges, while mitigating resolution degradation that typically occurs when changing a working distance or aperture value.



NEW HF-12M series 12 Megapixel, 2/3" 4D High Resolution



<Main features>

■ Advanced optical performance suitable for the top-of-the-range series

- When the iris (aperture) is set at the orange F4 marker on the lens barrel, the HF-12M series delivers the resolving power greater than 2.1μm pixel pitch on a 2/3-inch sensor (equivalent to 12 megapixels)*1.
- The HF-12M series is capable of maintaining ultra-high definition with a 2.7 μm pixel pitch within the whole frame area. Each pixel with high optical performance enables stable checking of product dimensions and appearance.
- The HF-12M series bring out maximum performance of the image sensor with 3.45μm pixel pitch(IMX250).



Orange-colored F4 marker on the lens barrel

■ FUJINON lenses' unique "4D High Resolution" performance. 4D High Resolution

General machine vision lenses share the issue of resolution degradation when the working distance or aperture is changed. The HF-12M features FUJINON lenses' unique "4D High Resolution" performance. It maintains a high level of consistent image sharpness at the center as well as around the edges, while mitigating resolution degradation that typically occurs when changing a working distance or aperture value. This enables the consistent delivery of high-resolution images under a wide variety of installation and shooting conditions.

■ Ease of installation and high reliability

- Despite being high-resolution lenses with 2.7μm pixel pitch, all the five models come in a compact form factor with the external dimension of just φ33mm. This allows installation flexibility even in manufacturing facilities with space constraints.
- General machine vision lenses use iris and focus locking screws with a head protruding out from the lens body, potentially causing interference within the machine vision system. The HF-12M series come with regular locking screws as well as headless compact screws, which can be countersunk into the lens body to minimize interference with the machine vision system, thereby increasing flexibility in system installation and design.
- The lenses are built with a metal barrel for durability and robustness.



When locked with a head-less compact screw. No head protruding from the lens body.

■ Industry-leading low distortion design of no more than 0.05%

- The lenses' unique optical design minimizes troublesome distortion. In industrial applications requiring accuracy such as dimension measurement. The series boasts an industry-leading low distortion rate of no more than 0.05%*2.
- The aspherical glass*3 mold lens enabled the smallest body and low distortion.

*1: At the working distance of 50cm *2: In the case of HF1618-12M *3: Installed to HF818-12M and HF1218-12M

Technology Supporting the "HF-12M Series"

High-precision glass mold aspherical lens technology –Achieving both miniaturization and low distortion–

- In lens design, reducing the number of lenses and forming an image by abruptly bending light that enters the lens achieves miniaturization. Distortion cannot be controlled if the lenses are only composed of the commonly used spherical lens. However, the aspherical lens can yield the same results of using multiple spherical lenses, enabling the control of distortion with far fewer lenses.

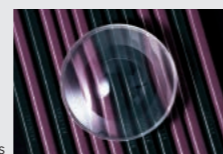

Aspherical lens

- Aspherical lenses require precision processing. Fujifilm can design and manufacture aspherical lens within its own group. The precision processing required in the design stage and its mass production is realized by accurate die machining technology.



General MV lens only with spherical lenses

MV lens with an aspherical lens

- The HF-12M series realizes both miniaturization and low distortion by implementing the high-precision glass mold aspherical lenses.

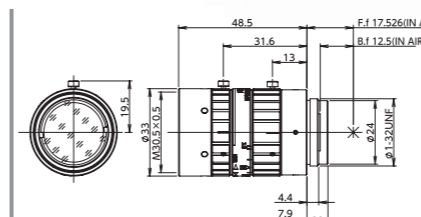

HF818-12M

Focal length [mm]	8
Iris range (F. no)	F1.8-F22
Angle of view	56.9°×43.9° (2/3")
Working Distance (*) [mm]	∞-100
Operation of focus	Manual
Operation of iris	Manual
Filter thread [mm]	M30.5 x 0.5
Mount	C-mount
Weight (approx.) [g]	95
Sensor size (max.)	2/3"
TV distortion [%]	-1.03
Dimension [mm]	φ33×48.5

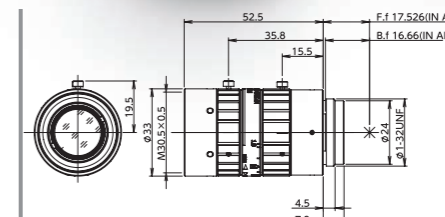

HF1218-12M

Focal length [mm]	12
Iris range (F. no)	F1.8-F22
Angle of view	39.3°×30.0° (2/3")
Working Distance (*) [mm]	∞-100
Operation of focus	Manual
Operation of iris	Manual
Filter thread [mm]	M30.5 x 0.5
Mount	C-mount
Weight (approx.) [g]	85
Sensor size (max.)	2/3"
TV distortion [%]	0.18
Dimension [mm]	φ33×52.5

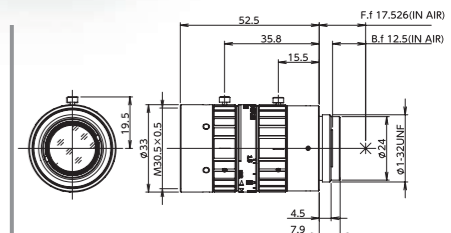

HF1618-12M

Focal length [mm]	16
Iris range (F. no)	F1.8-F22
Angle of view	30.8°×23.3° (2/3")
Working Distance (*) [mm]	∞-100
Operation of focus	Manual
Operation of iris	Manual
Filter thread [mm]	M30.5 x 0.5
Mount	C-mount
Weight (approx.) [g]	90
Sensor size (max.)	2/3"
TV distortion [%]	-0.03
Dimension [mm]	φ33×52.5

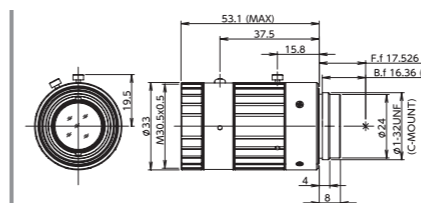

HF2518-12M

Focal length [mm]	25
Iris range (F. no)	F1.8-F22
Angle of view	20.0°×15.1° (2/3")
Working Distance (*) [mm]	∞-100
Operation of focus	Manual
Operation of iris	Manual
Filter thread [mm]	M30.5 x 0.5
Mount	C-mount
Weight (approx.) [g]	85
Sensor size (max.)	2/3"
TV distortion [%]	0.02
Dimension [mm]	φ33×53.1

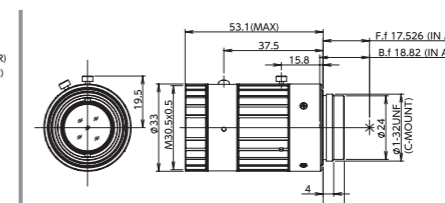

HF3520-12M

Focal length [mm]	35
Iris range (F. no)	F2.0-F22
Angle of view	14.7°×11.0° (2/3")
Working Distance (*) [mm]	∞-200
Operation of focus	Manual
Operation of iris	Manual
Filter thread [mm]	M30.5 x 0.5
Mount	C-mount
Weight (approx.) [g]	85
Sensor size (max.)	2/3"
TV distortion [%]	0.01
Dimension [mm]	φ33×53.1

* From front of lens barrel

Maintaining High-Resolution is about Controlling Aberration.

3 Technologies Supporting "4D High-Resolution"

1 Floating design technology

–Controls the drop in resolution caused by changing shooting distances–

- The lenses are designed to show the best resolution at the shooting distance most commonly used (designed distance). At this distance, the aberrations (color fringe/peripheral blur/distortion) are ideally corrected.
- Although conventional lens design technology optimally controlled aberration at the designed distance, aberration occurred at other distances and lowered resolution. The wide angle lens in particular had issues with its tendency for curvature of field (peripheral blur).
- The HF-12M series has implemented "floating design technology". "Floating lens elements" behind the iris move to focus and enable the HF-12M series to retain its highest resolution regardless of the shooting distance.

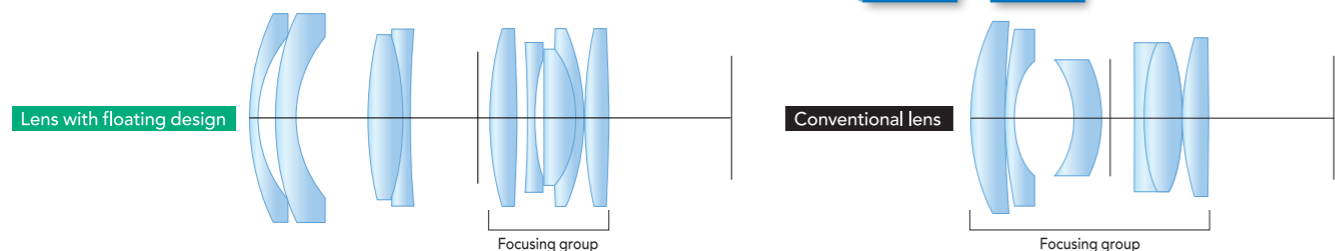
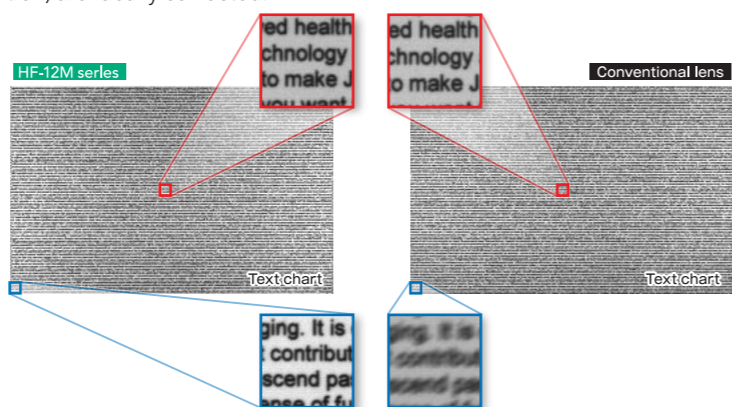

2 Eccentricity adjustment technology

–Retaining consistent resolution to the periphery of the image–

- Misalignment of the axis of the lenses during the manufacturing process prevents the intended performance from being exhibited. It is crucial to align the axis of the lenses to the micrometer level during its manufacturing process.
- The HF-12M series realized high-resolution consistent all the way to the periphery of the image. This is accomplished by detecting all lens core misalignment using proprietary inspection equipment of Fujifilm manufacturing technology and aligning the whole lens constructions with micrometer level adjustments.
- Fujifilm's proprietary manufacturing technology is utilized by applying the precision technology needed for manufacturing broadcast lenses that require high-dimensional and consistent qualities, to the manufacture of miniature lenses such as camera modules for mobile phones.

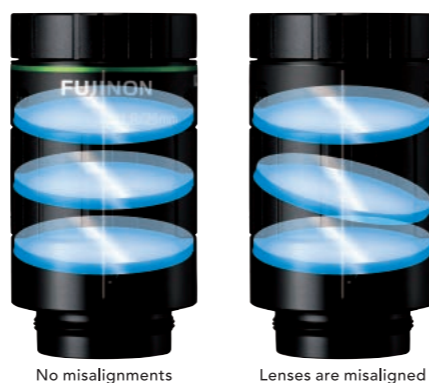

3 Glass matching technology (Fujifilm original optical design software "FOCUS")

–Controls the drop in resolution caused by changing aperture value–

- "Lateral chromatic aberration (color fringe)" is the main cause for the drop in resolution when changing the aperture value. Due to the different refractive index of the wavelength, imaging position sometimes differs by colors. This leads to the color fringing at the edge of the frame. To control of this aberration combination of the glass materials matters. While general glass materials can correct only the 2 colors of RGB(Red, Green, Blue), Extra-low Dispersion glass material enables the correction of all three colors at high level.
- By implementing glass with Extra-low Dispersion characteristics to control lateral chromatic aberration, the HF-12M series have succeeded to maintain the high resolution even when changing the aperture value.
- Fujifilm's has developed its original lens design software "FOCUS (Fujifilm Optical Class Library and Utilities System)", which enables to decide the best glass materials from the infinite combination of possibilities.

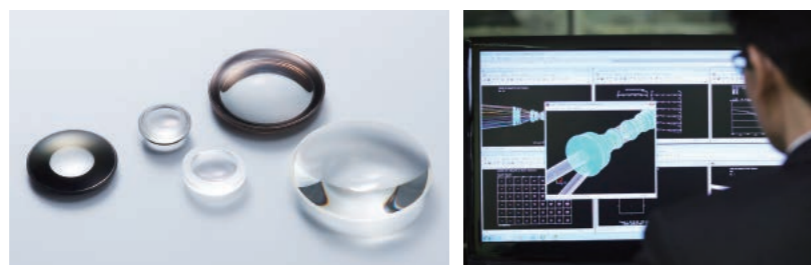

Please download the specification sheet and the drawing data.



NEW

HF-XA series 3 Megapixel, 2/3"

4D
High
Resolution

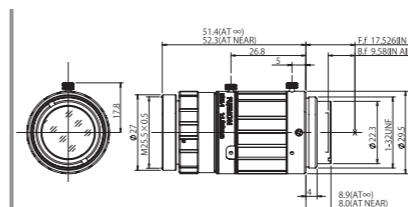

HF8XA-1

Focal length [mm]	8
Iris range (F. no)	F1.6-F16
Angle of view	58.4°×44.6° (2/3")
Working Distance (*) [mm]	∞-100
Operation of focus	Manual
Operation of iris	Manual
Filter thread [mm]	M25.5 x 0.5
Mount	C-mount
Weight (approx.) [g]	79
Sensor size (max.)	2/3"
TV distortion [%]	-1.99
Dimension [mm]	φ29.5×51.5

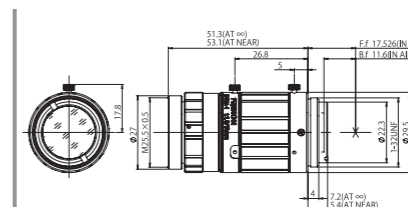

HF12XA-1

Focal length [mm]	12
Iris range (F. no)	F1.6-F16
Angle of view	40.1°×30.3° (2/3")
Working Distance (*) [mm]	∞-100
Operation of focus	Manual
Operation of iris	Manual
Filter thread [mm]	M25.5 x 0.5
Mount	C-mount
Weight (approx.) [g]	79
Sensor size (max.)	2/3"
TV distortion [%]	-1.26
Dimension [mm]	φ29.5×51.5

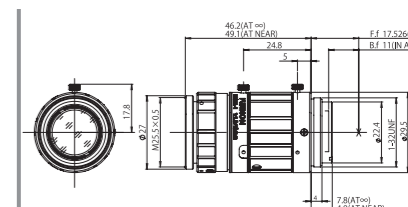

HF16XA-1

Focal length [mm]	16
Iris range (F. no)	F1.6-F16
Angle of view	31.4°×23.7° (2/3")
Working Distance (*) [mm]	∞-100
Operation of focus	Manual
Operation of iris	Manual
Filter thread [mm]	M25.5 x 0.5
Mount	C-mount
Weight (approx.) [g]	71
Sensor size (max.)	2/3"
TV distortion [%]	-0.60
Dimension [mm]	φ29.5×46.0

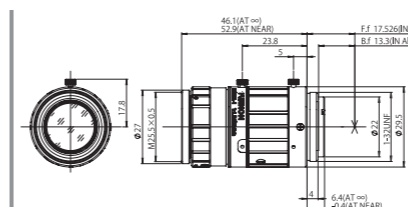

HF25XA-1

Focal length [mm]	25
Iris range (F. no)	F1.6-F16
Angle of view	20.0°×15.0° (2/3")
Working Distance (*) [mm]	∞-100
Operation of focus	Manual
Operation of iris	Manual
Filter thread [mm]	M25.5 x 0.5
Mount	C-mount
Weight (approx.) [g]	72
Sensor size (max.)	2/3"
TV distortion [%]	-0.07
Dimension [mm]	φ29.5×46.5

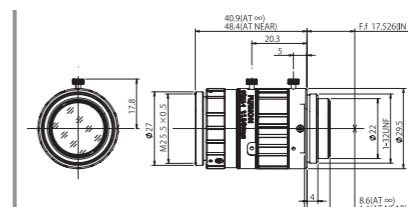

HF35XA-1

Focal length [mm]	35
Iris range (F. no)	F1.9-F16
Angle of view	14.2°×10.7° (2/3")
Working Distance (*) [mm]	∞-200
Operation of focus	Manual
Operation of iris	Manual
Filter thread [mm]	M25.5 x 0.5
Mount	C-mount
Weight (approx.) [g]	60
Sensor size (max.)	2/3"
TV distortion [%]	0.10
Dimension [mm]	φ29.5×41.5

* From front of lens barrel



HF-HA series 1.5 Megapixel, 2/3"

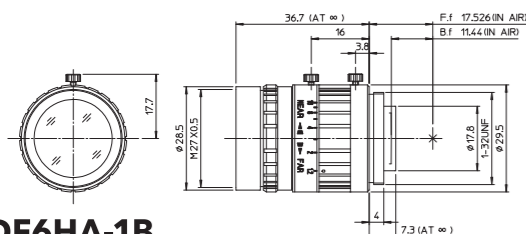

DF6HA-1B

Focal length [mm]	6
Iris range (F. no)	F1.2-F16
Angle of view	57.3°x 43.8°(1/2")
Working Distance (*) [mm]	∞-100
Operation of focus	Manual
Operation of iris	Manual
Filter thread [mm]	M27 x 0.5
Mount	C-mount
Weight (approx.) [g]	55
Sensor size (max.)	1/2"
TV distortion [%]	-1.84
Dimension [mm]	φ29.5×36.8

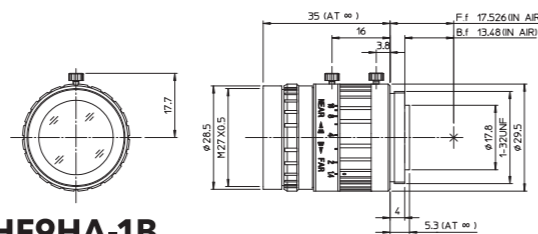

HF9HA-1B

Focal length [mm]	9
Iris range (F. no)	F1.4-F16
Angle of view	53.3°x 40.5°(2/3")
Working Distance (*) [mm]	∞-100
Operation of focus	Manual
Operation of iris	Manual
Filter thread [mm]	M27 x 0.5
Mount	C-mount
Weight (approx.) [g]	55
Sensor size (max.)	2/3"
TV distortion [%]	-2.00
Dimension [mm]	φ29.5×35

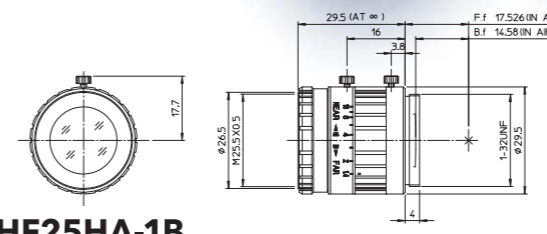

HF25HA-1B

Focal length [mm]	25
Iris range (F. no)	F1.4-F16
Angle of view	19.4°x 14.6°(2/3")
Working Distance (*) [mm]	∞-150
Operation of focus	Manual
Operation of iris	Manual
Filter thread [mm]	M25.5 x 0.5
Mount	C-mount
Weight (approx.) [g]	45
Sensor size (max.)	2/3"
TV distortion [%]	-0.19
Dimension [mm]	φ29.5×29.5

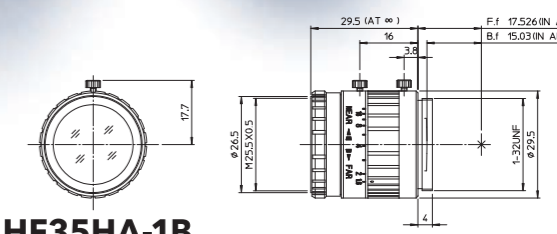

HF35HA-1B

Focal length [mm]	35
Iris range (F. no)	F1.6-F22
Angle of view	14.3°x 10.8°(2/3")
Working Distance (*) [mm]	∞-250
Operation of focus	Manual
Operation of iris	Manual
Filter thread [mm]	M25.5 x 0.5
Mount	C-mount
Weight (approx.) [g]	45
Sensor size (max.)	2/3"
TV distortion [%]	0.10
Dimension [mm]	φ29.5×29.5

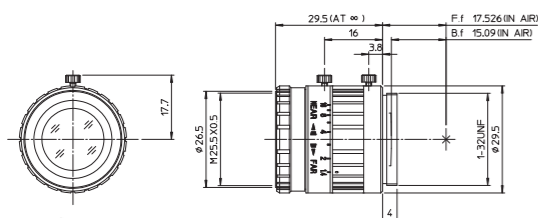

HF12.5HA-1B

Focal length [mm]	12.5
Iris range (F. no)	F1.4-F16
Angle of view	39.2°x 29.4°(2/3")
Working Distance (*) [mm]	∞-100
Operation of focus	Manual
Operation of iris	Manual
Filter thread [mm]	M25.5 x 0.5
Mount	C-mount
Weight (approx.) [g]	45
Sensor size (max.)	2/3"
TV distortion [%]	-1.95
Dimension [mm]	φ29.5×29.5

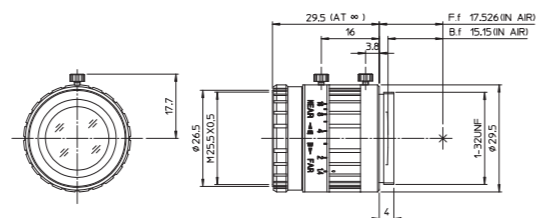

HF16HA-1B

Focal length [mm]	16
Iris range (F. no)	F1.4-F16
Angle of view	30.5°x 22.9°(2/3")
Working Distance (*) [mm]	∞-100
Operation of focus	Manual
Operation of iris	Manual
Filter thread [mm]	M25.5 x 0.5
Mount	C-mount
Weight (approx.) [g]	45
Sensor size (max.)	2/3"
TV distortion [%]	-0.87
Dimension [mm]	φ29.5×29.5

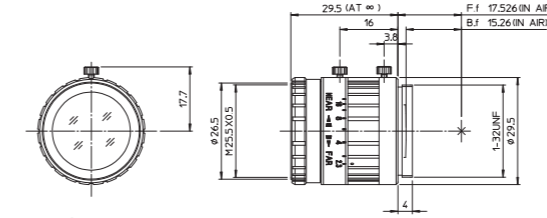

HF50HA-1B

Focal length [mm]	50
Iris range (F. no)	F2.3-F22
Working Distance (*) [mm]	10.1°x 7.6°(2/3")
Operation of focus	∞-500
Operation of iris	Manual
Filter thread [mm]	Manual
Mount	M25.5 x 0.5
Weight (approx.) [g]	C-mount
Sensor size (max.)	45
TV distortion [%]	2/3"
Dimension [mm]	0.06
	φ29.5×29.5

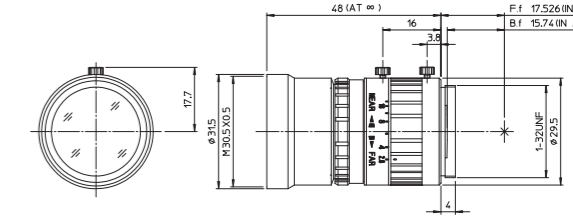

HF75HA-1B

Focal length [mm]	75
Iris range (F. no)	F2.8-F22
Angle of view	6.7°x 5.0°(2/3")
Working Distance (*) [mm]	∞-1,100
Operation of focus	Manual
Operation of iris	Manual
Filter thread [mm]	M30.5 x 0.5
Mount	C-mount
Weight (approx.) [g]	55
Sensor size (max.)	2/3"
TV distortion [%]	0.36
Dimension [mm]	φ29.5×48

* From front of lens barrel



Please download the specification sheet and the drawing data.



HF-SA series 5 Megapixel, 2/3"

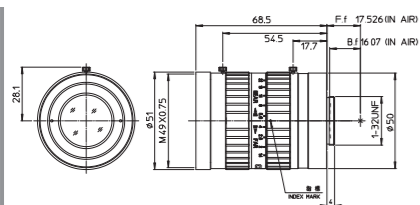

HF12.5SA-1

Focal length [mm]	12.5
Iris range (F. no)	F1.4-F22
Angle of view	38.0°x 29.0°(2/3")
Working Distance (*) [mm]	∞-100
Operation of focus	Manual
Operation of iris	Manual
Filter thread [mm]	M49 x 0.75
Mount	C-mount
Weight (approx.) [g]	295
Sensor size (max.)	2/3"
TV distortion [%]	-0.08
Dimension [mm]	φ51×68.5

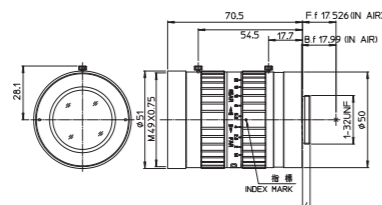

HF16SA-1

Focal length [mm]	16
Iris range (F. no)	F1.4-F22
Angle of view	30.2°x 22.9°(2/3")
Working Distance (*) [mm]	∞-100
Operation of focus	Manual
Operation of iris	Manual
Filter thread [mm]	M49 x 0.75
Mount	C-mount
Weight (approx.) [g]	285
Sensor size (max.)	2/3"
TV distortion [%]	0.11
Dimension [mm]	φ51×70.5

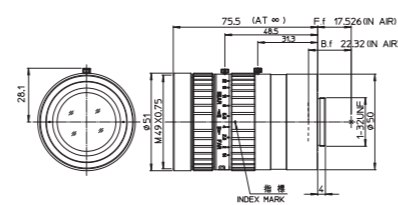

HF25SA-1

Focal length [mm]	25
Iris range (F. no)	F1.4-F22
Angle of view	20.8°x 15.7°(2/3")
Working Distance (*) [mm]	∞-100
Operation of focus	Manual
Operation of iris	Manual
Filter thread [mm]	M49 x 0.75
Mount	C-mount
Weight (approx.) [g]	315
Sensor size (max.)	2/3"
TV distortion [%]	-0.06
Dimension [mm]	φ51×75.5

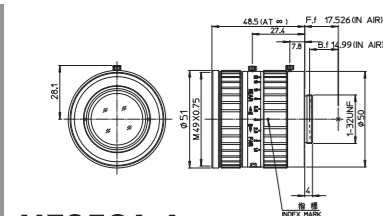

HF35SA-1

Focal length [mm]	35
Iris range (F. no)	F1.4-F22
Angle of view	14.0°x 10.5°(2/3")
Working Distance (*) [mm]	∞-200
Operation of focus	Manual
Operation of iris	Manual
Filter thread [mm]	M49 x 0.75
Mount	C-mount
Weight (approx.) [g]	185
Sensor size (max.)	2/3"
TV distortion [%]	0.07
Dimension [mm]	φ51×48.5

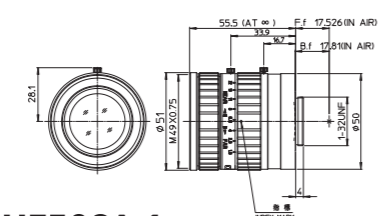

HF50SA-1

Focal length [mm]	50
Iris range (F. no)	F1.8-F22
Angle of view	9.7°x 7.3°(2/3")
Working Distance (*) [mm]	∞-400
Operation of focus	Manual
Operation of iris	Manual
Filter thread [mm]	M49 x 0.75
Mount	C-mount
Weight (approx.) [g]	240
Sensor size (max.)	2/3"
TV distortion [%]	0.08
Dimension [mm]	φ51×55.5

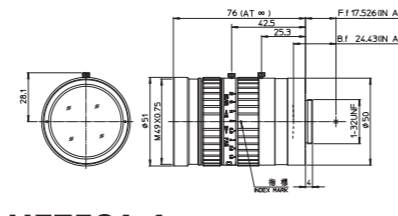

HF75SA-1

Focal length [mm]	75
Iris range (F. no)	F1.8-F22
Angle of view	6.7°x 5.0°(2/3")
Working Distance (*) [mm]	∞-900
Operation of focus	Manual
Operation of iris	Manual
Filter thread [mm]	M49 x 0.75
Mount	C-mount
Weight (approx.) [g]	305
Sensor size (max.)	2/3"
TV distortion [%]	0.01
Dimension [mm]	φ51×76

* From front of lens barrel



Please download the specification sheet and the drawing data.



CF-HA series 1.5 Megapixel, 1"

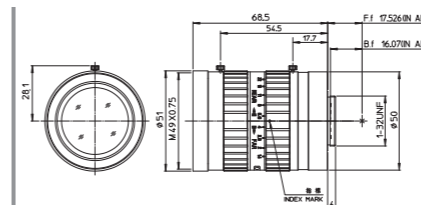

CF12.5HA-1

Focal length [mm]	12.5
Iris range (F. no)	F1.4-F22
Angle of view	53.1°x 41.2°(1")
Working Distance (*) [mm]	∞-100
Operation of focus	Manual
Operation of iris	Manual
Filter thread [mm]	M49 x 0.75
Mount	C-mount
Weight (approx.) [g]	290
Sensor size (max.)	1"
TV distortion [%]	0.86
Dimension [mm]	φ51×68.5

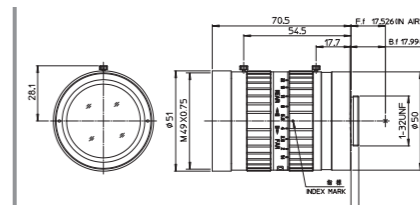

CF16HA-1

Focal length [mm]	16
Iris range (F. no)	F1.4-F22
Angle of view	42.6°x 32.8°(1")
Working Distance (*) [mm]	∞-100
Operation of focus	Manual
Operation of iris	Manual
Filter thread [mm]	M49 x 0.75
Mount	C-mount
Weight (approx.) [g]	280
Sensor size (max.)	1"
TV distortion [%]	0.79
Dimension [mm]	φ51×70.5

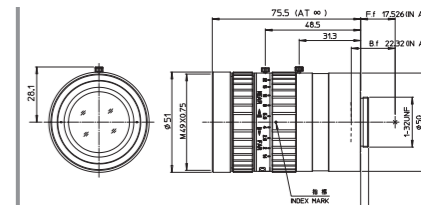

CF25HA-1

Focal length [mm]	25
Iris range (F. no)	F1.4-F22
Angle of view	29.9°x 22.7°(1")
Working Distance (*) [mm]	∞-100
Operation of focus	Manual
Operation of iris	Manual
Filter thread [mm]	M49 x 0.75
Mount	C-mount
Weight (approx.) [g]	310
Sensor size (max.)	1"
TV distortion [%]	0.36
Dimension [mm]	φ51×75.5

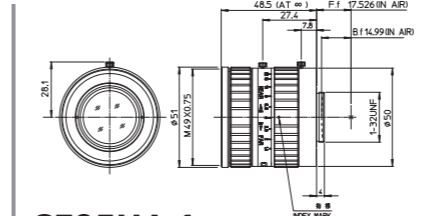

CF35HA-1

Focal length [mm]	35
Iris range (F. no)	F1.4-F22
Angle of view	20.3°x 15.3°(1")
Working Distance (*) [mm]	∞-200
Operation of focus	Manual
Operation of iris	Manual
Filter thread [mm]	M49 x 0.75
Mount	C-mount
Weight (approx.) [g]	180
Sensor size (max.)	1"
TV distortion [%]	0.18
Dimension [mm]	φ51×48.5

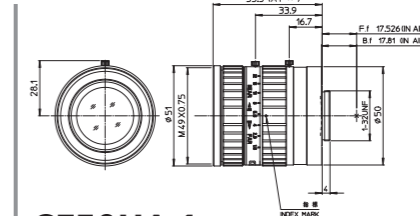

CF50HA-1

Focal length [mm]	50
Iris range (F. no)	F1.8-F22
Angle of view	14.1°x 10.6°(1")
Working Distance (*) [mm]	∞-400
Operation of focus	Manual
Operation of iris	Manual
Filter thread [mm]	M49 x 0.75
Mount	C-mount
Weight (approx.) [g]	235
Sensor size (max.)	1"
TV distortion [%]	0.20
Dimension [mm]	φ51×55.5

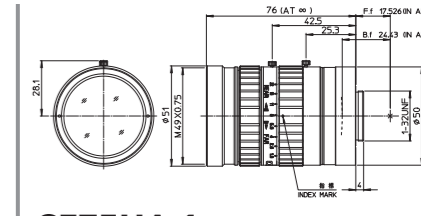

CF75HA-1

Focal length [mm]	75
Iris range (F. no)	F1.8-F22
Angle of view	9.8°x 7.3°(1")
Working Distance (*) [mm]	∞-900
Operation of focus	Manual
Operation of iris	Manual
Filter thread [mm]	M49 x 0.75
Mount	C-mount
Weight (approx.) [g]	300
Sensor size (max.)	1"
TV distortion [%]	0.01
Dimension [mm]	φ51×76

* From front of lens barrel



Please download the specification sheet and the drawing data.



TF series 3CCD, 1/3"

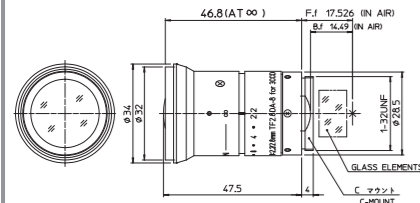

TF2.8DA-8	
Focal length [mm]	2.8
Iris range (F. no)	F2.2-F16·Close
Angle of view	89.1°x 69.3°(1/3")
Working Distance (*) [mm]	∞-100
Operation of focus	Manual
Operation of iris	Manual
Filter thread [mm]	-
Mount	C-mount
Weight (approx.) [g]	75
Sensor size (max.)	1/3"
TV distortion [%]	-6.25
Dimension [mm]	φ34×47.5

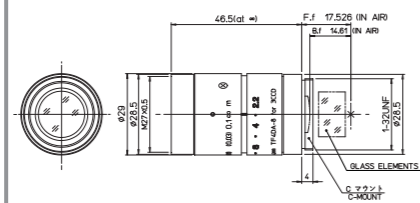

TF4DA-8	
Focal length [mm]	4
Iris range (F. no)	F2.2-F16·Close
Angle of view	64.5°x 49.0°(1/3")
Working Distance (*) [mm]	∞-100
Operation of focus	Manual
Operation of iris	Manual
Filter thread [mm]	M27 x 0.5
Mount	C-mount
Weight (approx.) [g]	70
Sensor size (max.)	1/3"
TV distortion [%]	-3.77
Dimension [mm]	φ29×46.5

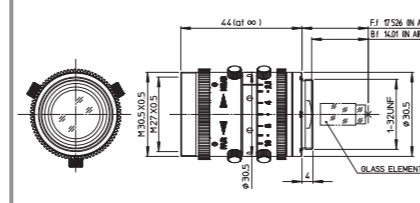

TF4XA-1 2MP	
Focal length [mm]	4
Iris range (F. no)	F2.2
Angle of view	64.5°x 49.1°(1/3")
Working Distance (*) [mm]	∞-100
Operation of focus	Manual
Operation of iris	Manual
Filter thread [mm]	M27 x 0.5 (INSIDE) M30.5x0.5 (OUTSIDE)
Mount	C-mount
Weight (approx.) [g]	100
Sensor size (max.)	1/3"
TV distortion [%]	-4.27
Dimension [mm]	φ30.5×44

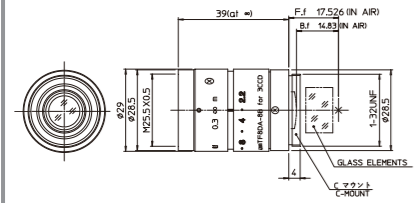

TF8DA-8B	
Focal length [mm]	8
Iris range (F. no)	F2.2-F16·Close
Angle of view	33.4°x 25.1°(1/3")
Working Distance (*) [mm]	∞-100
Operation of focus	Manual
Operation of iris	Manual
Filter thread [mm]	M25.5 x 0.5
Mount	C-mount
Weight (approx.) [g]	60
Sensor size (max.)	1/3"
TV distortion [%]	-1.30
Dimension [mm]	φ29×39

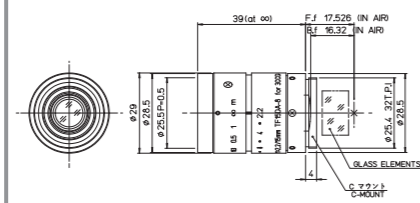

TF15DA-8	
Focal length [mm]	15
Iris range (F. no)	F2.2-F16·Close
Angle of view	18.0°x 13.5°(1/3")
Working Distance (*) [mm]	∞-100
Operation of focus	Manual
Operation of iris	Manual
Filter thread [mm]	M25.5 x 0.5
Mount	C-mount
Weight (approx.) [g]	60
Sensor size (max.)	1/3"
TV distortion [%]	-0.31
Dimension [mm]	φ29×39

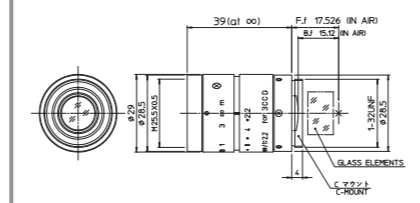

TF25DA-8B	※ This product is for sale while stock lasts.
Focal length [mm]	25
Iris range (F. no)	F2.2-F16·Close
Angle of view	11.0°x 8.3°(1/3")
Working Distance (*) [mm]	∞-200
Operation of focus	Manual
Operation of iris	Manual
Filter thread [mm]	M25.5 x 0.5
Mount	C-mount
Weight (approx.) [g]	60
Sensor size (max.)	1/3"
TV distortion [%]	-0.06
Dimension [mm]	φ29×39

* From front of lens barrel

Optical Magnification Ratio Chart [Reference data]

SAMPLE		Product name		HF9HA-1B	
Extension tube (mm)		Focal Length		f9	
Focus		Shooting range (HxV)			
WD#		NEAR		FAR	
2/3"		15.4x11.1		17.7x12.8	
1/2"		10.7x7.9		12.3x9.1	
1/3"		7.9x5.9		9.1x6.7	
mag		0.624x		0.542x	
Sensor size		Sensor size		Sensor size	
		※ Working distance		← Lens magnification	
				Sensor size	
				1" 12.8x9.6	
				2/3" 8.8x6.6	
				1/2" 6.4x4.8	
				1/3" 4.8x3.6	

HF-12M series

Extension tube (mm)	Product name	HF818-12M	HF1218-12M	HF1618-12M	HF2518-12M	HF3520-12M
	Focal Length	f8	f12	f16	f25	f35
	Focus	Shooting range (HxV)		Shooting range (HxV)		Shooting range (HxV)
0	WD	100	100	100	100	200
	2/3"	123.7x92.0	84.8x63.5	66.6x49.8	42.3x31.7	53.2x39.8
	1/2"	89.1x66.6	61.6x46.2	48.3x36.1	30.7x23.0	38.6x29.0
0.5	WD	48	67	77	90	183
	2/3"	67.5x50.1	61.1x45.7	53.7x40.2	38.6x28.9	48.9x36.6
	1/2"	48.6x36.2	44.3x33.2	38.9x29.2	28.0x21.0	35.5x26.6
1	WD	28	48	62	81	169
	2/3"	46.5x34.5	47.8x35.7	45.0x33.7	35.5x26.6	45.2x33.9
	1/2"	33.4x24.9	34.6x25.9	32.6x24.4	25.8x19.3	32.8x24.6
1.5	WD	18	36	51	73	157
	2/3"	35.5x26.3	39.2x29.3	38.7x29.0	32.9x24.6	42.1x31.5
	1/2"	25.5x19.0	28.4x21.3	28.1x21.0	23.9x17.9	30.6x22.9
2	WD	12	28	42	67	146
	2/3"	28.7x21.3	33.3x24.9	34.0x25.4	30.6x22.9	39.3x29.5
	1/2"	20.6x15.4	24.1x18.0	24.6x18.5	22.2x16.6	28.6x21.4
5	WD	6	12	17	42	103
	2/3"	17.5x13.0	22.0x16.4	19.6x14.7	21.7x16.2	28.3x21.2
	1/2"	12.6x9.4	15.9x11.9	14.2x10.6	15.7x11.7	20.5x15.4
10	WD	3	6	9	22	68
	2/3"	11.5x8.6	14.2x10.6	14.6x10.9	22.1x16.5	19.3x14.4
	1/2"	8.3x6.2	10.3x7.7	10.5x7.9	10.5x7.9	14.0x10.5
15	WD	2	4	6	15	41
	2/3"	11.0x8.2	14.8x11.0	14.6x10.9	11.0x8.2	15.1x11.3
	1/2"	7.9x5.9	10.7x8.0	10.6x8.0	8.0x6.0	11.0x8.2
20	WD	1	2	3	8	21
	2/3"	8.8x6.6	11.1x8.3	11.8x8.8	8.8x6.6	11.0x8.2
	1/2"	6.4x4.8	8.0x6.0	8.5x6.4	6.4x4.8	8.2x6.2
25	WD	1	1	1	1	1
	2/3"	8.8x6.6	11.1x8.3	11.8x8.8	8.8x6.6	11.0x8.2
	1/2"	6.4x4.8	8.0x6.0	8.5x6.4	6.4x4.8	8.2x6.2
30	WD	1	1	1	1	1
	2/3"	8.8x6.6	11.1x8.3	11.8x8.8	8.8x6.6	11.0x8.2
	1/2"	6.4x4.8	8.0x6.0	8.5x6.4	6.4x4.8	8.2x6.2
35	WD	1	1	1	1	1
	2/3"	8.8x6.6	11.1x8.3	11.8x8.8	8.8x6.6	11.0x8.2
	1/2"	6.4x4.8	8.0x6.0	8.5x6.4	6.4x4.8	8.2x6.2
40	WD	1	1	1	1	1
	2/3"	8.8x6.6	11.1x8.3	11.8x8.8	8.8x6.6	11.0x8.2
	1/2"	6.4x4.8	8.0x6.0	8.5x6.4	6.4x4.8	8.2x6.2
45	WD	1	1	1	1	1
	2/3"	8.8x6.6	11.1x8.3	11.8x8.8	8.8x6.6	11.0x8.2
	1/2"	6.4x4.8	8.0x6.0	8.5x6.4	6.4x4.8	8.2x6.2
50	WD	1	1	1	1	1
	2/3"	8.8x6.6	11.1x8.3	11.8x8.8	8.8x6.6	11.0x8.2
	1/2"	6.4x4.8	8.0x6.0	8.5x6.4	6.4x4.8	8.2x6.2
70	WD	1	1	1	1	1
	2/3"	8.8x6.6	11.1x8.3	11.8x8.8	8.8x6.6	11.0x8.2
	1/2"	6.4x4.8	8.0x6.0	8.5x6.4	6.4x4.8	8.2x6.2

Technical Information

Image Sizes

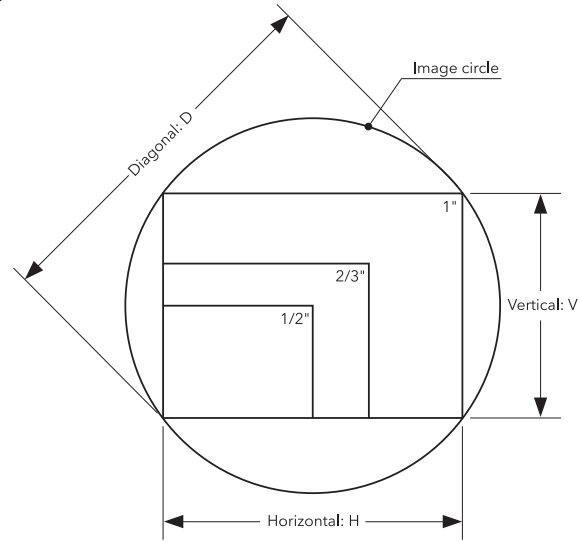

There are several types of imaging sensors for FA cameras, with different image sizes. The aspect ratio of FA camera is normally 4:3 (H:V).

Product symbol	Image sensor	Image size (mm)		
		Horizontal:H	Vertical:V	Diagonal:D
C	1"	12.8	9.6	16.0
H	2/3"	8.8	6.6	11.0
D	1/2"	6.4	4.8	8.0
35mm camera lens (Reference)	35mm Film	36.0	24.0	43.3

Angle of View

The angle of view is the object size that can be captured at a specified image size, which is represented by angular measure. Normally the angle of view is measured assuming a lens is focused at infinity. When using a lens of the same focal length with a different image size, the angle of view will differ.

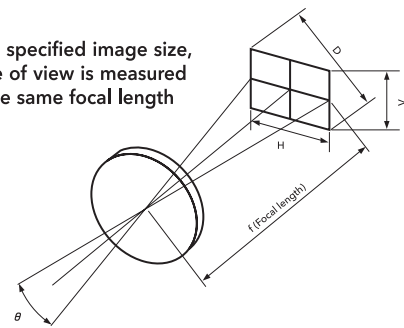

$$\theta = 2 \tan^{-1} \frac{Y'}{2f}$$

θ : Angle of view
 Y' : Image size
 f : Focal length

Eg. The angle of view when the camera size is 1/2" and the focal length is 12.5mm:

$$\theta = 2 \tan^{-1} \frac{6.4}{2 \times 12.5} = 28.72^\circ$$

Depth of Field

When focusing on a certain area in front of and behind the deep object appears in focus. This area is called the depth of field. This is because the focus appears sharp if the focus misalignment is under a certain volume. This certain volume is called the permissible circle of confusion.

- The depth of field has following properties.
- 1)The larger the F No. is, the wider the depth of field becomes.
 - 2)The shorter the focal length is, the wider the depth of field becomes.
 - 3)The longer the distance to the object is, the wider depth of field becomes.
 - 4)The backward depth of field is wider than the forward depth of field.

Image sensor	Permissible circle of confusion
1"	0.03 mm
2/3"	0.021 mm
1/2"	0.015 mm
1/3"	0.011 mm
1/4"	0.008 mm

The depth of field can be calculated by the following formula.

$$\text{Backward depth of field } Tr = \frac{\delta \cdot F \cdot L^2}{f^2 - \delta \cdot F \cdot L}$$

$$\text{Forward depth of field } Tf = \frac{\delta \cdot F \cdot L^2}{f^2 + \delta \cdot F \cdot L}$$

$$\text{Depth of field} = Tr + Tf$$

$$\text{Focal depth} = 2 \delta \cdot F$$

f : Focal distance
 F : F No.
 δ : Permissible circle diameter of confusion
 L : Object distance

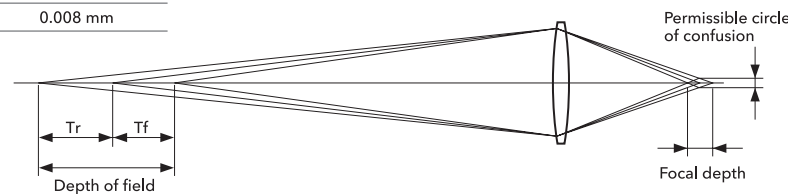

Focal Length

The focal length will be the distance from the back principal point to the image plane. Lower the focal length wider the image

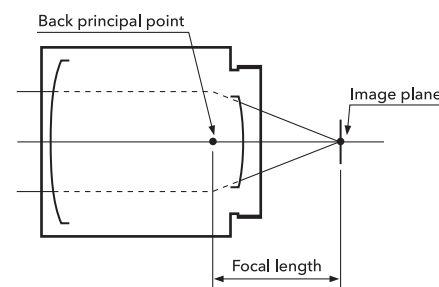

Brightness of a Lens (F No.)

The F No. is an indication of the brightness of lens. The smaller the value, the brighter the image produced by the lens. The F No. is inversely proportional to the effective diameter of the lens and directly proportional to the focal length.

The F No. is a value determined on the assumption that the transmittance of the lens is 100%. Virtually all lenses however, have different spectral transmittance, and thus, the same F No. can have different levels of brightness.

$$F \text{ No.} = \frac{f}{d}$$

f : Focal length of a lens
 d : Effective diameter of a lens

Field of View and Focal Length

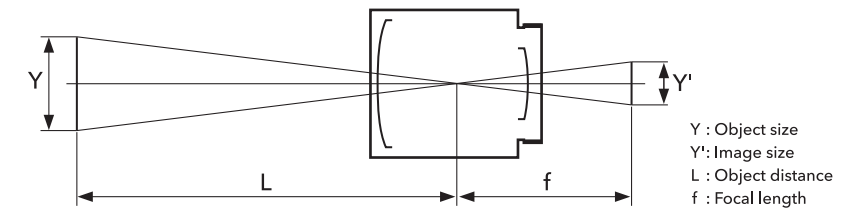

(1) How to calculate the field of view

If the distance to the object is finite, you can use the following formula to calculate the field of view.

$$Y = Y' \cdot \frac{L}{f}$$

Eg. 1/3" CCD camera with an 8mm lens is used, and the distance to the object is 3m. The maximum horizontal width as viewed on the monitor can be calculated as follows.

$Y' : 4.8$
 $L : 3000$
 $f : 8$

$$Y = 4.8 \times \frac{3000}{8} = 1800 \rightarrow \text{Horizontal width 1.8 m}$$

(2) How to calculate focal length

If the distance to the object is finite, you can use the following formula to calculate the focal length.

$$f = Y' \cdot \frac{L}{Y}$$

Eg. 1/3" CCD camera with an 8mm lens is used, and the distance to the object is 3m. The maximum horizontal width as viewed on the monitor can be calculated as follows.

$Y' : 4.8$
 $L : 3000$
 $Y : 2000$

$$f = 4.8 \times \frac{3000}{2000} = 7.2 \rightarrow \text{Focal length approx. 7 mm}$$

Distortion

Distortion is an aberration where the geometric figure of the object is not reproduced faithfully at the image plane. It is normally represented by the level shift of an image point from its ideal position by a percentage of image height or width.

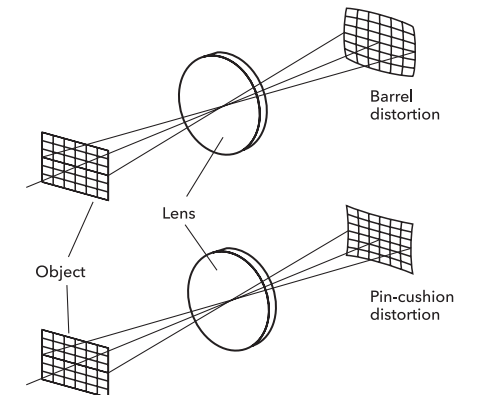

MTF (Modulation Transfer Function)

MTF (Modulation Transfer Function) represents the declining contrast rate when shooting a chart consisted of black and white lines.

