

# Digital Control Units for LED Light Units: PD3 Series

Patent Pending

High Performance and with Choice of External Control



Digital Control Units with High Performance and with Choice of External Control

# PD3 series

Select from a total of nine models in three groups:

3-channel 28-W Models, 4-channel 46-W Models, and 8-channel 95-W Models.

● Compact and Easy to Use: 3-channel, 28-W Models **PD3-3024-3 Control Units**



PD3-3024-3-PI

Parallel Communications

Capacity: 28 W

3 Channels

Connects to 24V Light Units



PD3-3024-3-SI

EIA-485 Communications

Capacity: 28 W

3 Channels

Connects to 24V Light Units



PD3-3024-3-EI

Ethernet Communications

Capacity: 28 W

3 Channels

Connects to 24V Light Units



Number of channels

● Ample Capacity and Many Connectable Light Units: **PD3-5024-4 Control Units**  
4-channel, 46-W Models



PD3-5024-4-PI

Parallel Communications

Capacity: 46 W

4 Channels

Connects to 24V Light Units

Connects to HLV2 Spotlights



PD3-5024-4-SI

EIA-485 Communications

Capacity: 46 W

4 Channels

Connects to 24V Light Units

Connects to HLV2 Spotlights



PD3-5024-4-EI

Ethernet Communications

Capacity: 46 W

4 Channels

Connects to 24V Light Units

Connects to HLV2 Spotlights

● Connects to High-output Light Units:  
8-channel, 95-W Models

**PD3-10024-8 Control Units**



PD3-10024-8-PI

Parallel Communications

Capacity: 95 W

4 Channels

Connects to 24V Light Units

Connects to HLV2 Spotlights



PD3-10024-8-SI

EIA-485 Communications

Capacity: 95 W

4 Channels

Connects to 24V Light Units

Connects to HLV2 Spotlights



PD3-10024-8-EI

Ethernet Communications

Capacity: 95 W

4 Channels

Connects to 24V Light Units

Connects to HLV2 Spotlights

**Higher capacity and more channels**

# Product Lineup Table

		PD3-3024-3 Control Units			PD3-5024-4 Control Units			PD3-10024-8 Control Units		
Model numbers (PD3-)		3024-3-PI	3024-3-SI	3024-3-EI	5024-4-PI	5024-4-SI	5024-4-EI	10024-8-PI	10024-8-SI	10024-8-EI
Number of channels		3 channels			4 channels			8 channels		
Rated capacity (Total output for all channels)		Total for all channels 28 W			Total for all channels 46 W <sup>*4</sup>			Total for all channels 95 W <sup>*4</sup> <sup>*5</sup> <sup>*6</sup>		
Applicable Light Units	24V Light Units	Supported.			Supported.			Supported.		
	HLV2-series Spotlights <sup>*1</sup>	—			Supported.			Supported.		
External control method	Parallel communications	Supported.	—	—	Supported.	—	—	Supported.	—	—
	EIA-485 communications	—	Supported.	—	—	Supported.	—	—	Supported.	—
	Ethernet communications (TCP/IP or UDP/IP)	—	—	Supported.	—	—	Supported.	—	—	Supported.
External controls	External light intensity control	Supported.			Supported.			Supported.		
	ON/OFF control	Supported. (External trigger input)	Supported. (External trigger input or command input via EIA-485 communications)	Supported. (External trigger input or command input via Ethernet communications)	Supported. (External trigger input)	Supported. (External trigger input or command input via EIA-485 communications)	Supported. (External trigger input or command input via Ethernet communications)	Supported. (External trigger input)	Supported. (External trigger input or command input via EIA-485 communications)	Supported. (External trigger input or command input via Ethernet communications)
	Strobe lighting (24V Light Units only) <sup>*2</sup> <sup>*3</sup>	Supported. (External trigger input)			Supported. (External trigger input)			Supported. (External trigger input)		
	Lighting times	40 µs, 80 µs, 120 µs, 200 µs, 600 µs, 1 ms, 4 ms, 10 ms, 20 ms, or 40 ms			40 µs, 80 µs, 120 µs, 200 µs, 600 µs, 1 ms, 4 ms, 10 ms, 20 ms, or 40 ms			40 µs, 80 µs, 120 µs, 200 µs, 600 µs, 1 ms, 4 ms, 10 ms, 20 ms, or 40 ms		
	Lighting delay time	10 µs max.			20 µs max.			20 µs max.		
Power consumption		78 VA typ.			70 VA typ.			130 VA typ.		
Size (W × D × H)		84 mm × 82.6 mm × 120 mm			197 mm × 82.6 mm × 120 mm			220 mm × 82.6 mm × 120 mm		
Weight		600 g max.			1,200 g max.			1,500 g max.		

\*1 The HLV-14-R/-SW/-BL/GR and HLV-27-series Spotlights cannot be used.

\*2 Strobe lighting is not possible for HLV2-series Spotlights.

\*3 These Control Units do not include an overdrive.

\*4 HLV2-series Spotlights: 3.9 W (700 mA) max. per connector.

\*5 24V Light Units: 60 W max. per connector.

\*6 High-output Light Unit connector only: 95 W max.

# PD3 series

## PD3-series Basic Performance



### 1

## One Power Supply for Constant Lighting, ON/OFF Lighting, and Strobe Lighting.

\* Strobe lighting is not possible for HLV2-series Spotlights.

PWM control is possible at a frequency of 125 kHz. The light intensity can be adjusted to any of 256 levels. ON/OFF and strobe lighting control is synchronized with an external trigger signal. The lighting time can be set to any of 10 settings.

### ■ Strobe Lighting Times

40  $\mu$ s, 80  $\mu$ s, 120  $\mu$ s, 200  $\mu$ s, 600  $\mu$ s, 1 ms, 4 ms, 10 ms, 20 ms, or 40 ms

\* These Control Units do not include an overdrive.

### 2

## Easy to Use. Digital Displays for Easy Setting

The easy-to-use user interface emphasizes easy operation. The digital display and pushbutton dial are only part of the new design features of these Digital Control Units.

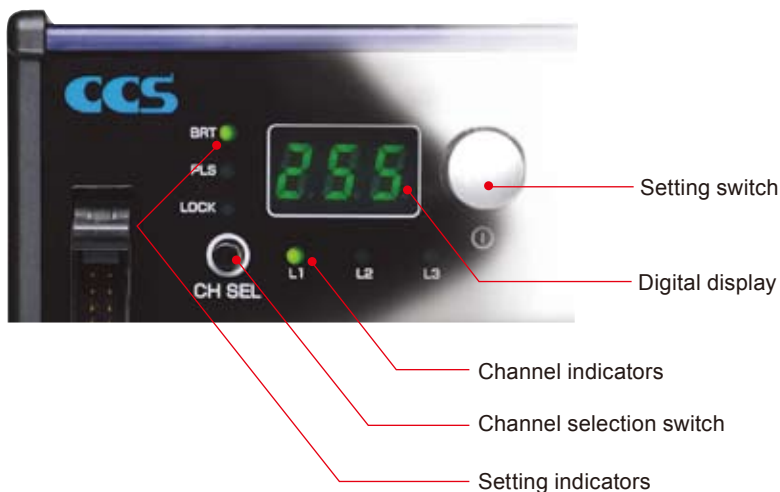

### Quick Operation with a Pushbutton Dial

- Intensity setting to 256 levels.
- Strobe lighting time setting
- Setting lock

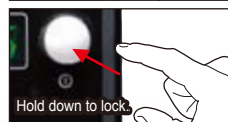
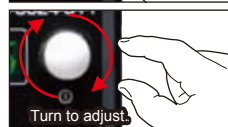

# 3

## Ethernet Communications. Selection of Three Types of External Control

The lineup includes models with external control through parallel, EIA-485, or Ethernet communications to suit any network environment.

# 4

## Standard DIN Rail Mounting. Selection of Installation Method to Match the Site

\* These installation examples show a PD3-3024-3 Control Unit.



● Free-standing Installation



● Bottom-mounted Installation (Option Required)



● Installation on DIN Rail

# 5

## Connection of Both 24V Light Units and HLV2-series Spotlights to 46-W or 95-W Control Units

**46-W Control Unit**

**95-W Control Unit**

**HLV2-series Spotlight connectors**

**Applicable Light Units**

- HLV2-series
- HLV2-22-NR-3W-series
- HLV2-3M-RGB-3W
- HLV-24-series
- HLV-24-3W-series
- HLV-24-NR-series
- HLV-24-NR-3W-series
- HLV-3M-RGB-3W

**24V Light Unit connectors (3-pole)**

**Applicable Light Units** Light Units with 24V input

**PD3-10024-8 Control Unit**

**24V Light Unit**

**HLV2-14-series**

**Connection Examples**

- Connect many 24V Light Units of different types.
- Connect HLV2-series Spotlights.
- Connect 24V Light Units and HLV2-series Spotlights at the same time.
- Connect a High-output 24V Light Unit (95-W Control Unit only).
- Etc.

**95-W connector (maximum capacity)**

**24V Light Unit connector (2-pole)**

**Applicable Light Units** High-output Light Unit with 24V input

## Parallel Communications for Quick Changeover of Settings and High-speed Data Transfer.

PD3-3024-3-PI



- Capacity: 28 W
- 3 Channels
- Connects to 24V Light Units

PD3-5024-4-PI



- Capacity: 46 W
- 4 Channels
- Connects to 24V Light Units
- Connects to HLV2 Spotlights

PD3-10024-8-PI



- Capacity: 95 W
- 8 Channels
- Connects to 24V Light Units
- Connects to HLV2 Spotlights

**External Light Intensity Control**

Control the light intensity to 256 levels with parallel communications.

**ON/OFF Control**

Turn the Light Units ON or OFF by inputting an external trigger signal.

**Strobe Lighting**

\* Possible only for 24V Light Units.

Turn ON the Light Units for the set time after inputting the external trigger signal.

Strobe Lighting Times  
40 μs, 80 μs, 120 μs, 200 μs, 600 μs,  
1 ms, 4 ms, 10 ms, 20 ms, or 40 ms  
\* These Control Units do not include an overdrive.

### Examples of Combining External Control Cables

\* The External Control Cable is sold as an option.

#### External Control with Parallel Communications

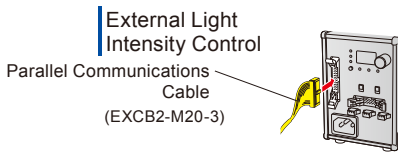

#### External Control with Trigger Input

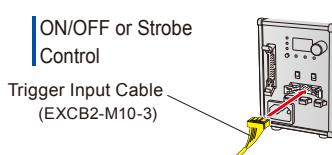

#### External Control with Parallel Communications and Trigger Input

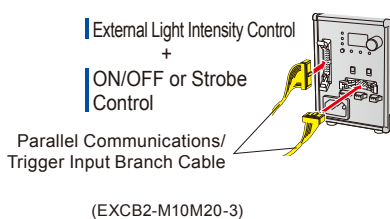

### Communications Example

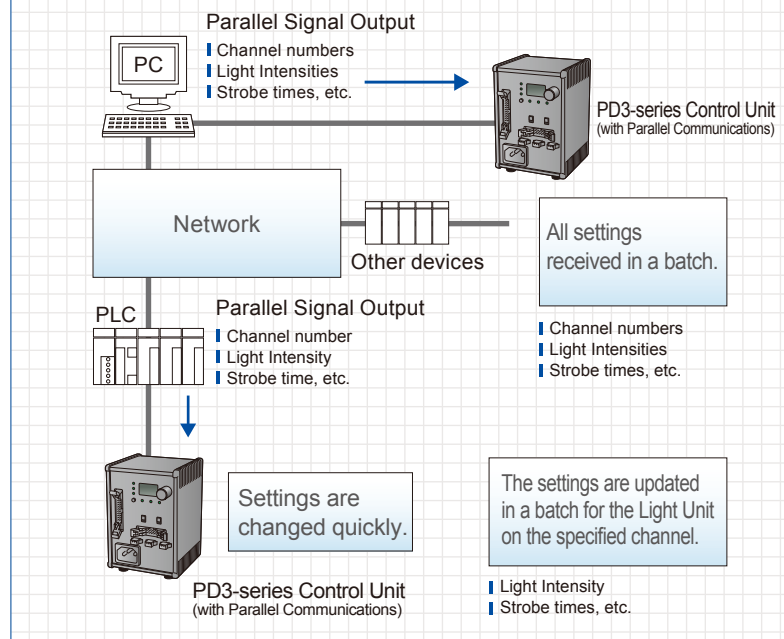

## EIA-485 Serial Communications for ID Management on Multidrop Wiring. Manage Up to Four Control Units.

PD3-3024-3-SI



- Capacity: 28 W
- 3 Channels
- Connects to 24V Light Units

PD3-5024-4-SI



- Capacity: 46 W
- 4 Channels
- Connects to 24V Light Units
- Connects to HLV2 Spotlights

PD3-10024-8-SI



- Capacity: 95 W
- 8 Channels
- Connects to 24V Light Units
- Connects to HLV2 Spotlights

**External Light Intensity Control**  
Control the light intensity to 256 levels with command inputs on EIA-485 communications.

**ON/OFF Control**  
• External trigger signal input  
• Command input via EIA-485 communications  
Turn the Light Units ON or OFF with inputs.

**Strobe Lighting**  
\* Possible only for 24V Light Units.  
Turn ON the Light Units for the set time after inputting the external trigger signal.

Strobe Lighting Times  
40  $\mu$ s, 80  $\mu$ s, 120  $\mu$ s, 200  $\mu$ s, 600  $\mu$ s,  
1 ms, 4 ms, 10 ms, 20 ms, or 40 ms

\* These Control Units do not include an overdrive.

### Examples of Combining External Control Cables

\* The External Control Cable is sold as an option.

#### External Control with EIA-485 Communications

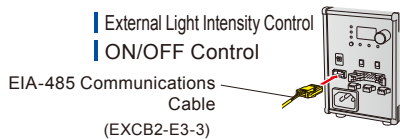

#### External Control with Trigger Input

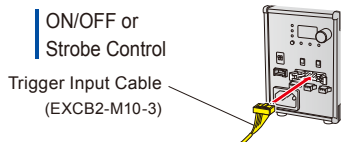

\* You can also use the EIA-485 Communications Cable and the Trigger Input Cable together.

#### Communications Specifications

Protocol	EIA-485 compliant
Baud rate	19200 bps
Data bit length	8 bits
Parity bit	None
Stop bits	1 bit

### Communications Example

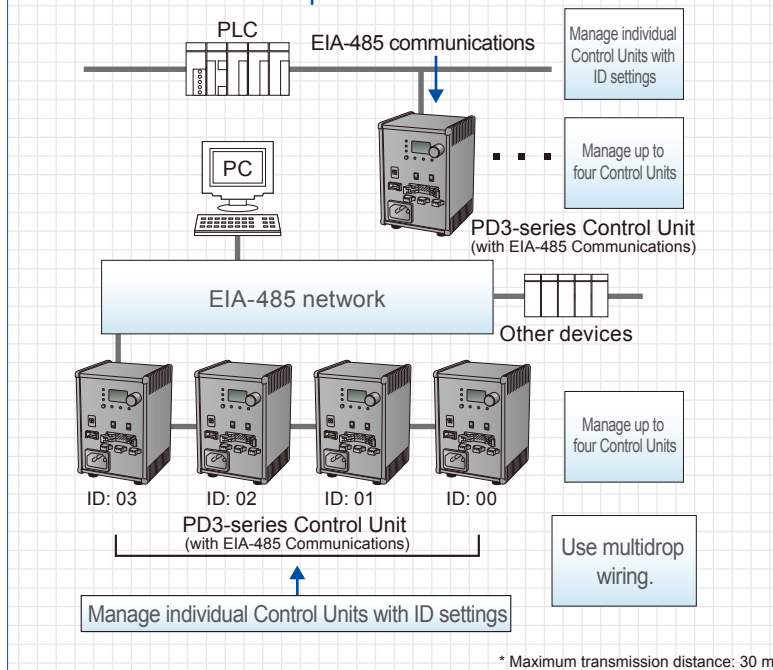

\* For multidrop wiring, use the optional EXCB2-E3-E3-0.2 EIA-485 Communications Relay Cable.

## Ethernet Communications with Standard TCP/IP and UDP/IP Protocols. The User-friendly Solution.

PD3-3024-3-EI



- Capacity: 28 W
- 3 Channels
- Connects to 24V Light Units

PD3-5024-4-EI



- Capacity: 46 W
- 4 Channels
- Connects to 24V Light Units
- Connects to HLV2 Spotlights

PD3-10024-8-EI



- Capacity: 95 W
- 8 Channels
- Connects to 24V Light Units
- Connects to HLV2 Spotlights

### External Light Intensity Control

Control the light intensity to 256 levels with command inputs on Ethernet communications.

### ON/OFF Control

- External trigger signal input
  - Command input via Ethernet communications
- Turn the Light Units ON or OFF with inputs.

### Strobe Lighting

\* Possible only for 24V Light Units.  
Turn ON the Light Units for the set time after inputting the external trigger signal.

Strobe Lighting Times  
40 μs, 80 μs, 120 μs, 200 μs, 600 μs,  
1 ms, 4 ms, 10 ms, 20 ms, or 40 ms

\* These Control Units do not include an overdrive.

### Examples of Combining External Control Cables

#### External Control via Ethernet Communications

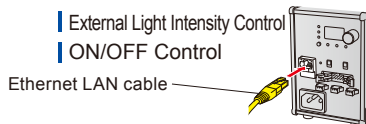

#### External Control with Trigger Input

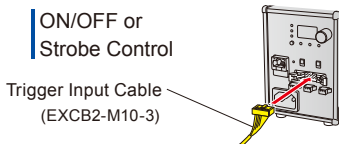

\* The External Control Cable is sold as an option.

\* You can also use the LAN cable and the Trigger Input Cable together.

#### Communications Specifications

Communications protocol	TCP/IP UDP/IP
Standards	IEEE802.3, IEEE802.3u, and IEEE802.3x
Baud rate	10 Mbps/100 Mbps (Automatically detected.)
Transmission medium	10Base-T or 100Base-TX

### Communications Example

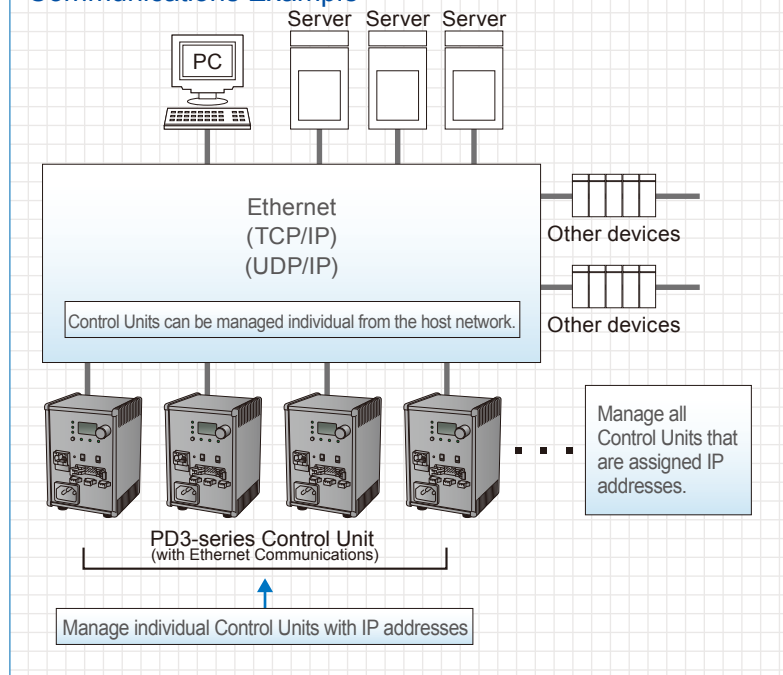



# PD3-3024-3 Series

## Common Specifications

Lighting method	Constant lighting/strobe lighting
Drive method	Constant-voltage system
Light intensity control method	PWM control and lighting time control
Number of channels	3 channels
Applicable Light Units (rated)	24V DC input, Total for all channels: 28 W
PWM frequency	125 kHz
Error detection display	Front-panel digital OCP display
Overcurrent protection*	Operates at 107% of rated output current or higher. Reset by pressing operation setting switch for at least 1 second or by cycling the power supply.
Input voltage (rated)	100 to 240V AC
Power consumption (typ.)	78 VA
Frequency	50/60 Hz
Output voltage (rated)	24V DC
Output current (rated)	Total for 3 channels: 1.1 A
Operating temperature and humidity	Temperature: 0 to 40°C, Humidity: 20% to 85% (with no condensation)
Storage temperature and humidity	Temperature: -20 to 60°C, Humidity: 20% to 85% (with no condensation)
Cooling method	Natural air cooling
CE Marking	Safety standard: Conforms to EN 61010-1, EMC standard: Conforms to EN 61326, Class A.
Material and surface processing	Material: Aluminum and resin, Surface processing: Blue alumite
Weight	600 g max.
Accessories	2-m long 3-prong power cord with ground terminal

\* Do not intentionally short-circuit the positive and negative output terminals.

## PD3-3024-3-PI (Control Unit with Parallel Communications) Specifications

Direct number	2000775	
Light intensity setting	Manual	Set to any of 256 levels on front-panel setting switch.
	External	8-bit input (B0 to B7), write pulse (BRTWR), and channel selection (CHSEL0 to CHSEL2)
ON/OFF setting	External trigger input	
Lighting mode setting	Manual	Set to any of 11 levels on front-panel setting switch.
	External	4-bit input (M0 to M3), write pulse (TRGWWR), and channel selection (CHSEL0 to CHSEL2)
Error detection output	NPN transistor output between pins 19 (OC) and 20 (OE) of external control connector Normal: Open    Overcurrent output detected: Closed	
External control connector	Trigger input	MIL connector, 10 pins
	Lighting intensity/lighting mode setting	MIL connector, 20 pins

## PD3-3024-3-SI (Control Unit with EIA-485 Serial Communications) Specifications

Direct number	2000777	
Light intensity setting	Manual	Set to any of 256 levels on front-panel setting switch.
	External	Command input via EIA-485 communications
ON/OFF setting	External trigger input or command input via EIA-485 communications	
Lighting mode setting	Manual	Set to any of 11 levels on front-panel setting switch.
	External	Command input via EIA-485 communications
Error detection output	Command sent when overcurrent output is detected.	
External control connector	Trigger input	MIL connector, 10 pins
	Lighting intensity/lighting mode setting	e-CON connector, 3 pins

## PD3-3024-3-EI (Control Unit with Ethernet Communications) Specifications

Direct number	2000776	
Light intensity setting	Manual	Set to any of 256 levels on front-panel setting switch.
	External	Command input via TCP/IP or UDP/IP communications
ON/OFF setting	External trigger input or command input via TCP/IP or UDP/IP communications	
Lighting mode setting	Manual	Set to any of 11 levels on front-panel setting switch.
	External	Command input via TCP/IP or UDP/IP communications
Error detection output	Command sent when overcurrent output is detected.	
External control connector	Trigger input	MIL connector, 10 pins
	Lighting intensity/lighting mode setting	RJ-45 connector

\* Direct Numbers: You can easily access the information page for any of our products by entering the product's 7-digit direct number in the designated box on the CCS website (image processing page).

## Dimension Diagrams (mm)

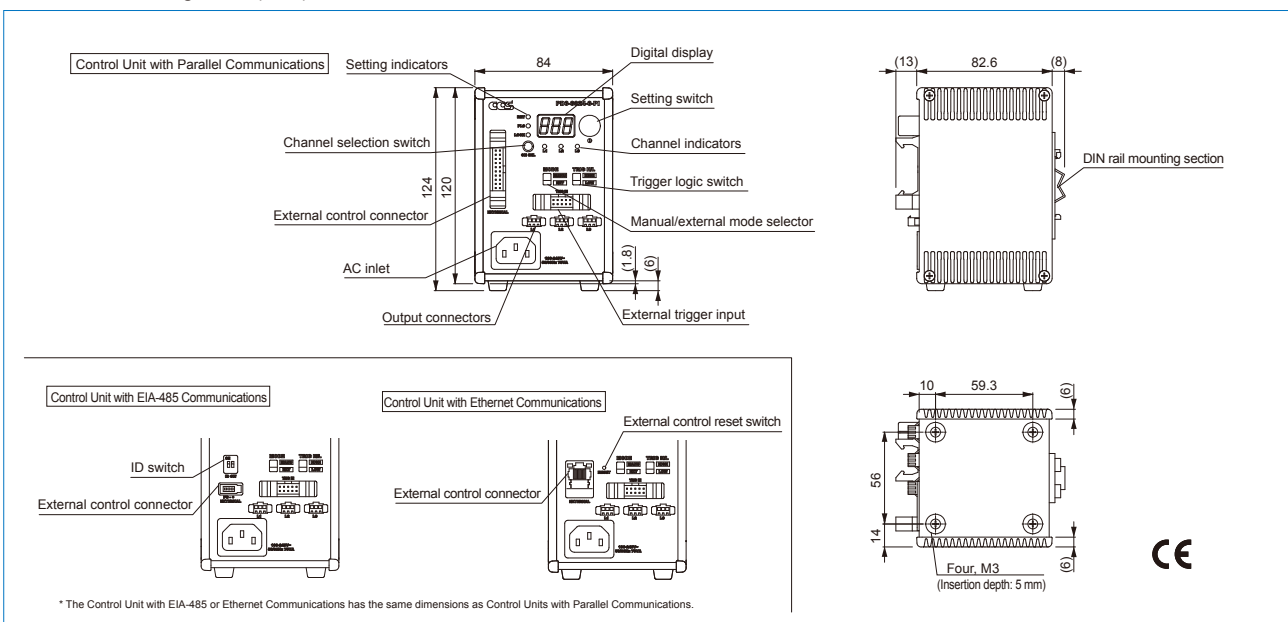

# PD3-5024-4 Series

## Common Specifications

Lighting method	Constant lighting/strobe lighting
Drive method	24V LIGHT connectors: Constant-voltage system, HLV LIGHT connectors: Constant-current system
Light intensity control method	24V LIGHT connectors: PWM control and lighting time control, HLV LIGHT connectors: Variable-current control
Number of channels	4 channels
Applicable Light Units (rated)	24V LIGHT connectors: Light Units with 24V DC input, HLV LIGHT connectors: HL2V/HLV-series Spotlights, Total for 4 channels: 46 W
PWM frequency	125 kHz
Error detection display	Front-panel digital OCP display: Overcurrent error, EFN display: Fan Stop Error, and EID display: ID error (HL2V/HLV-series Spotlights only)
Overcurrent protection	Operates at 107% of rated output current or higher. Reset by pressing operation setting switch for at least 1 second or by cycling the power supply. * Do not intentionally short-circuit the positive and negative output terminals.
Input voltage (rated)	100 to 240V AC
Power consumption (typ.)	70 VA
Frequency	50/60 Hz
Output voltage (rated)	24V DC
Output current (rated)	Total for 4 channels: 1.91 A
Operating temperature and humidity	Temperature: 0 to 40°C, Humidity: 20% to 85% (with no condensation)
Storage temperature and humidity	Temperature: -20 to 60°C, Humidity: 20% to 85% (with no condensation)
Cooling method	Forced air cooling
CE Marking	Safety standard: Conforms to EN 61010-1, EMC standard: Conforms to EN 61326, Class A.
Material and surface processing	Material: Aluminum and resin, Surface processing: Blue alumite
Weight	1,200 g max.
Accessories	2-m long 3-prong power cord with ground terminal, Base Brackets

\* HLV LIGHT connectors: Strobe lighting is not possible for HL2V-series Spotlights. The HLV-14-R/-SW/-BL/GR and HLV-27-series Spotlights cannot be used. \* Strobe lighting is possible only with 24V Light Units. (These Control Units do not include an overdrive.)

## PD3-5024-4-PI (Control Unit with Parallel Communications) Specifications

Direct number	2000778	
Light intensity setting	Manual	Set to any of 256 levels on front-panel setting switch.
	External	8-bit input (B0 to B7), write pulse (BRTWR), and channel selection (CHSEL0 to CHSEL2)
ON/OFF setting	External trigger input	
Lighting mode setting	Manual	Set to any of 11 levels on front-panel setting switch.
	External	4-bit input (M0 to M3), write pulse (TRGWR), and channel selection (CHSEL0 to CHSEL2)
Error detection output	NPN transistor output between pins 19 (OC) and 20 (OE) of external control connector Normal: Open Overcurrent output detected: Closed	
External control connector	Trigger input	MIL connector, 10 pins
	Lighting intensity/lighting mode setting	MIL connector, 20 pins

## PD3-5024-4-SI (Control Unit with EIA-485 Serial Communications) Specifications

Direct number	2000780	
Light intensity setting	Manual	Set to any of 256 levels on front-panel setting switch.
	External	Command input via EIA-485 communications
ON/OFF setting	External trigger input or command input via EIA-485 communications	
Lighting mode setting	Manual	Set to any of 11 levels on front-panel setting switch.
	External	Command input via EIA-485 communications
Error detection output	Command sent when overcurrent output is detected.	
External control connector	Trigger input	MIL connector, 10 pins
	Lighting intensity/lighting mode setting	e-CON connector, 3 pins

## PD3-5024-4-EI (Control Unit with Ethernet Communications) Specifications

Direct number	2000779	
Light intensity setting	Manual	Set to any of 256 levels on front-panel setting switch.
	External	Command input via TCP/IP or UDP/IP communications
ON/OFF setting	External trigger input or command input via TCP/IP or UDP/IP communications	
Lighting mode setting	Manual	Set to any of 11 levels on front-panel setting switch.
	External	Command input via TCP/IP or UDP/IP communications
Error detection output	Command sent when overcurrent output is detected.	
External control connector	Trigger input	MIL connector, 10 pins
	Lighting intensity/lighting mode setting	RJ-45 connector

\* Direct Numbers: You can easily access the information page for any of our products by entering the product's 7-digit direct number in the designated box on the CCS website (image processing page).

## Dimension Diagrams (mm)

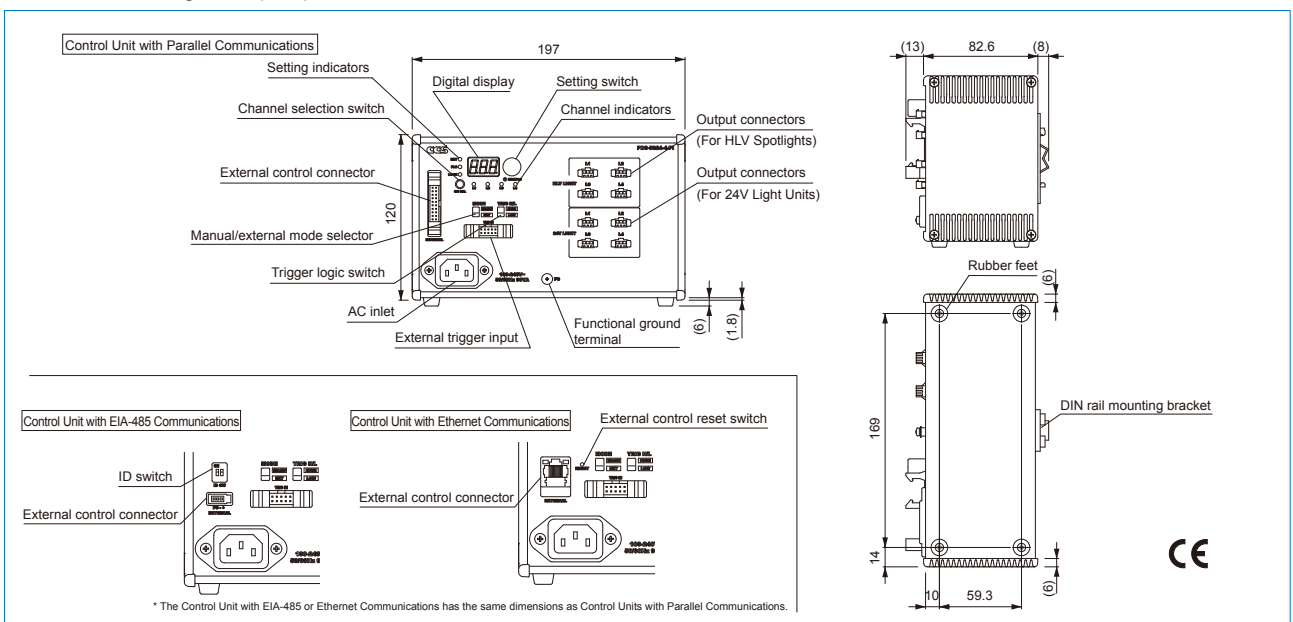

# PD3-10024-8 Series

## Common Specifications

Lighting method	Constant lighting/strobe lighting
Drive method	24V LIGHT connectors: Constant-voltage system, HLV LIGHT connectors: Constant-current system
Light intensity control method	24V LIGHT connectors: PWM control and lighting time control, HLV LIGHT connectors: Variable-current control
Number of channels	8 channels
Applicable Light Units (rated)	24V LIGHT connectors: Light Units with 24V DC input, HLV LIGHT connectors: HL2/HLV-series Spotlights, Total for 8 channels: 95W (High-output Light Unit connector: 95 W (1 connector))
PWM frequency	125kHz
Error detection display	Front-panel digital OCP display: Overcurrent error, EFN display: Fan Stop Error, and EID display: ID error (HLV2/HLV-series Spotlights only)
Overcurrent protection	Operates at 107% of rated output current or higher. Reset by pressing operation setting switch for at least 1 second or by cycling the power supply. * Do not intentionally short-circuit the positive and negative output terminals.
Input voltage (rated)	100 to 240V AC
Power consumption (typ.)	130 VA
Frequency	50/60 Hz
Output voltage (rated)	24V DC
Output current (rated)	Total for 8 channels: 3.95 A
Operating temperature and humidity	Temperature: 0 to 40°C, Humidity: 20% to 85% (with no condensation)
Storage temperature and humidity	Temperature: -20 to 60°C, Humidity: 20% to 85% (with no condensation)
Cooling method	Forced air cooling
CE Marking	Safety standard: Conforms to EN 61010-1, EMC standard: Conforms to EN 61326, Class A.
Material and surface processing	Material: Aluminum and resin, Surface processing: Blue alumite
Weight	1,500 g max.
Accessories	2-m long 3-prong power cord with ground terminal, Base Brackets

\* HLV LIGHT connectors: Strobe lighting is not possible for HL2-series Spotlights. The HL2-14-R/-SW/-BL/GR and HL2-27-series Spotlights cannot be used. \* Strobe lighting is possible only with 24V Light Units. (These Control Units do not include an overdrive.)

## PD3-10024-8-PI (Control Unit with Parallel Communications) Specifications

Direct number	2000781	
Light intensity setting	Manual	Set to any of 256 levels on front-panel setting switch.
	External	8-bit input (B0 to B7), write pulse (BRTWR), and channel selection (CHSEL0 to CHSEL2)
ON/OFF setting	External trigger input	
Lighting mode setting	Manual	Set to any of 11 levels on front-panel setting switch.
	External	4-bit input (M0 to M3), write pulse (TRGWR), and channel selection (CHSEL0 to CHSEL2)
Error detection output	NPN transistor output between pins 19 (OC) and 20 (OE) of external control connector Normal: Open Overcurrent output detected: Closed	
External control connector	Trigger input	MIL connector, 10 pins
	Lighting intensity/lighting mode setting	MIL connector, 20 pins

## PD3-10024-8-SI (Control Unit with EIA-485 Serial Communications) Specifications

Direct number	2000783	
Light intensity setting	Manual	Set to any of 256 levels on front-panel setting switch.
	External	Command input via EIA-485 communications
ON/OFF setting	External trigger input or command input via EIA-485 communications	
Lighting mode setting	Manual	Set to any of 11 levels on front-panel setting switch.
	External	Command input via EIA-485 communications
Error detection output	Command sent when overcurrent output is detected.	
External control connector	Trigger input	MIL connector, 10 pins
	Lighting intensity/lighting mode setting	e-CON connector, 3 pins

## PD3-10024-8-EI (Control Unit with Ethernet Communications) Specifications

Direct number	2000782	
Light intensity setting	Manual	Set to any of 256 levels on front-panel setting switch.
	External	Command input via TCP/IP or UDP/IP communications
ON/OFF setting	External trigger input or command input via TCP/IP or UDP/IP communications	
Lighting mode setting	Manual	Set to any of 11 levels on front-panel setting switch.
	External	Command input via TCP/IP or UDP/IP communications
Error detection output	Command sent when overcurrent output is detected.	
External control connector	Trigger input	MIL connector, 10 pins
	Lighting intensity/lighting mode setting	RJ-45 connector

\* Direct Numbers: You can easily access the information page for any of our products by entering the product's 7-digit direct number in the designated box on the CCS website (image processing page).

## Dimension Diagrams (mm)

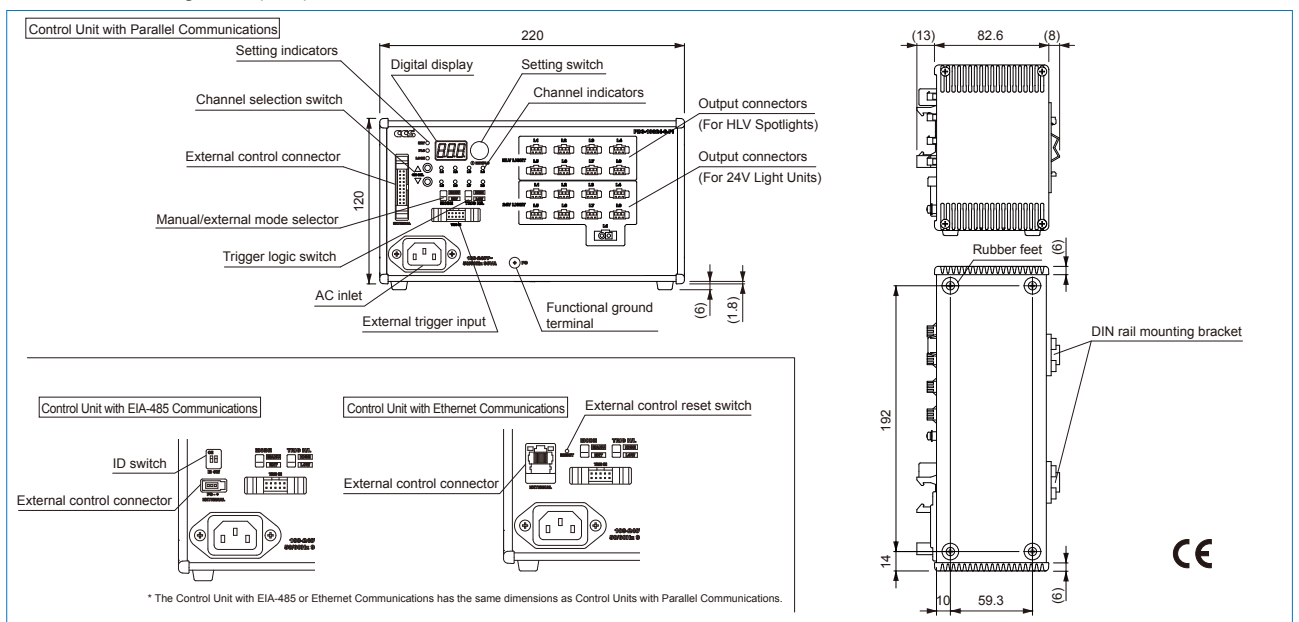

\* The Control Unit with EIA-485 or Ethernet Communications has the same dimensions as Control Units with Parallel Communications.

# Options

## External Control Cables

### Parallel Communications Cable

This Cable is used for external control with parallel communications. The channel, light intensity setting, and lighting mode (constant mode, ON/OFF mode, or strobe mode) can be selected.



### Dimension Diagrams (mm)

Direct number: 3000683  
Model: EXCB2-M20-3

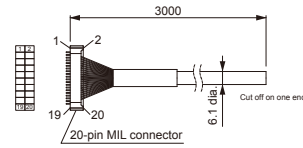

PIN No.	Wire color	Marks	PIN No.	Wire color	Marks
1	Orange	Black 1	11	Orange	Black 2
2	Orange	Red 1	12	Orange	Red 2
3	Gray	Black 1	13	Gray	Black 2
4	Gray	Red 1	14	Gray	Red 2
5	White	Black 1	15	White	Black 2
6	White	Red 1	16	White	Red 2
7	Yellow	Black 1	17	Yellow	Black 2
8	Yellow	Red 1	18	Yellow	Red 2
9	Pink	Black 1	19	Pink	Black 2
10	Pink	Red 1	20	Pink	Red 2

### Trigger Input Cable

This cable is used to input an external trigger signal using parallel bits. The external trigger signal can be used to turn Light Units ON or OFF, or to flash the strobes.



Direct number: 3000682  
Model: EXCB2-M10-3

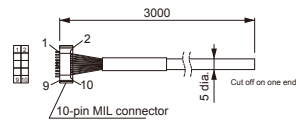

PIN No.	Wire color	Marks
1	Orange	Black 1
2	Orange	Red 1
3	Gray	Black 1
4	Gray	Red 1
5	White	Black 1
6	White	Red 1
7	Yellow	Black 1
8	Yellow	Red 1
9	Pink	Black 1
10	Pink	Red 1

### EIA-485 Serial Communications Cable

This Cable is used for external control with EIA-485 communications. The channel, light intensity setting, ON/OFF setting, and lighting mode (constant mode, ON/OFF mode, or strobe mode) can be selected.



Direct number: 3000685  
Model: EXCB2-E3-3

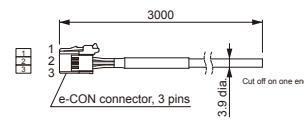

PIN No.	Wire color	Embedded line color
1	Black	None
2	Black	White
3 (shield)	Drain wire	None

### EIA-485 Serial Communications Relay Cable

This Cable is required to connect two or more PD3-series Control Units with EIA-485 communications.



Direct number: 3000721  
Model: EXCB2-E3-E3-0.2

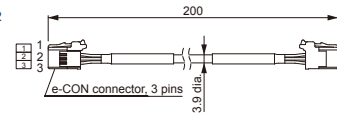

Relay connector  
Direct number: 3000720  
Model: ECNR-E3CN4

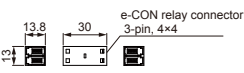

### Parallel Communications/Trigger Input Branch Cable

This Cable includes the Parallel Communications Cable and the Trigger Input Cable in one cable.



Direct number: 3000684  
Model: EXCB2-M10M20-3

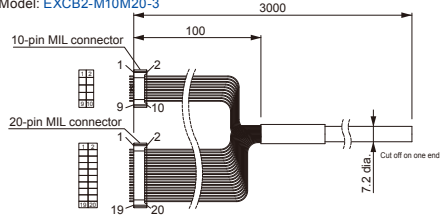

10-pin MIL connector		20-pin MIL connector			
PIN No.	Wire color	Marks	PIN No.	Wire color	Marks
1	Orange	Black 1	11	Orange	Black 2
2	Orange	Red 1	12	Orange	Red 2
3	Gray	Black 1	13	Gray	Black 2
4	Gray	Red 1	14	Gray	Red 2
5	White	Black 1	15	White	Black 2
6	White	Red 1	16	White	Red 2
7	Yellow	Black 1	17	Yellow	Black 2
8	Yellow	Red 1	18	Yellow	Red 2
9	Pink	Black 1	19	Pink	Black 2
10	Pink	Red 1	20	Pink	Red 2

## Base Brackets

These Brackets are used to secure a PD3-series Control Unit to the floor, a shelf, or other surface.



\* The Base Brackets are included with the PD3-5024-4 and PD3-10024-8 Control Units.

Direct number: 4001164  
Model: BK-PD3

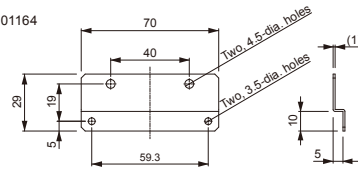

\* 1 set (2 Brackets)

● CCS and LIGHTING SOLUTION are all registered trademarks or trademarks of CCS, Inc.

### Caution

- To ensure proper and safe use of the product, please read the Instruction Guide completely before using the product.
- For product improvement, specifications and designs are subject to change without notice.

**CCS Inc.**  
CREATIVE CUSTOMER SATISFACTION

### Headquarters

Shimodachiuri-agaru, Karasuma-dori, Kamigyo-ku, Kyoto 602-8011 Japan  
Phone: +81-75-415-8284 / Fax: +81-75-415-8278  
URL: <http://www.ccs-grp.com> E-mail: [intlsales@ccs-inc.co.jp](mailto:intlsales@ccs-inc.co.jp)