 **Warning** Handle the projector correctly in accordance with the user's manual to ensure safe use.

\*Product specifications, appearance, price, etc. are subject to change without advance notice.

\*Product colors in this catalog may differ in appearance from the actual product due to photography and printing conditions.

FFBX-2022.04



## Advanced Safety, Security and Quality

FUJIFILM has brought together its optical technology, developed over many years, and unique image processing technology to offer a new solution in long-range surveillance systems.



## Supporting various interfaces to enable diverse system administration

The SX800 supports both serial communications [RS485] and IP communications [ONVIF] so that it can be incorporated into customers' existing systems in place. The RS485 protocol supports Pelco-D / Pelco-P\* and can be downloaded from the FUJIFILM website.

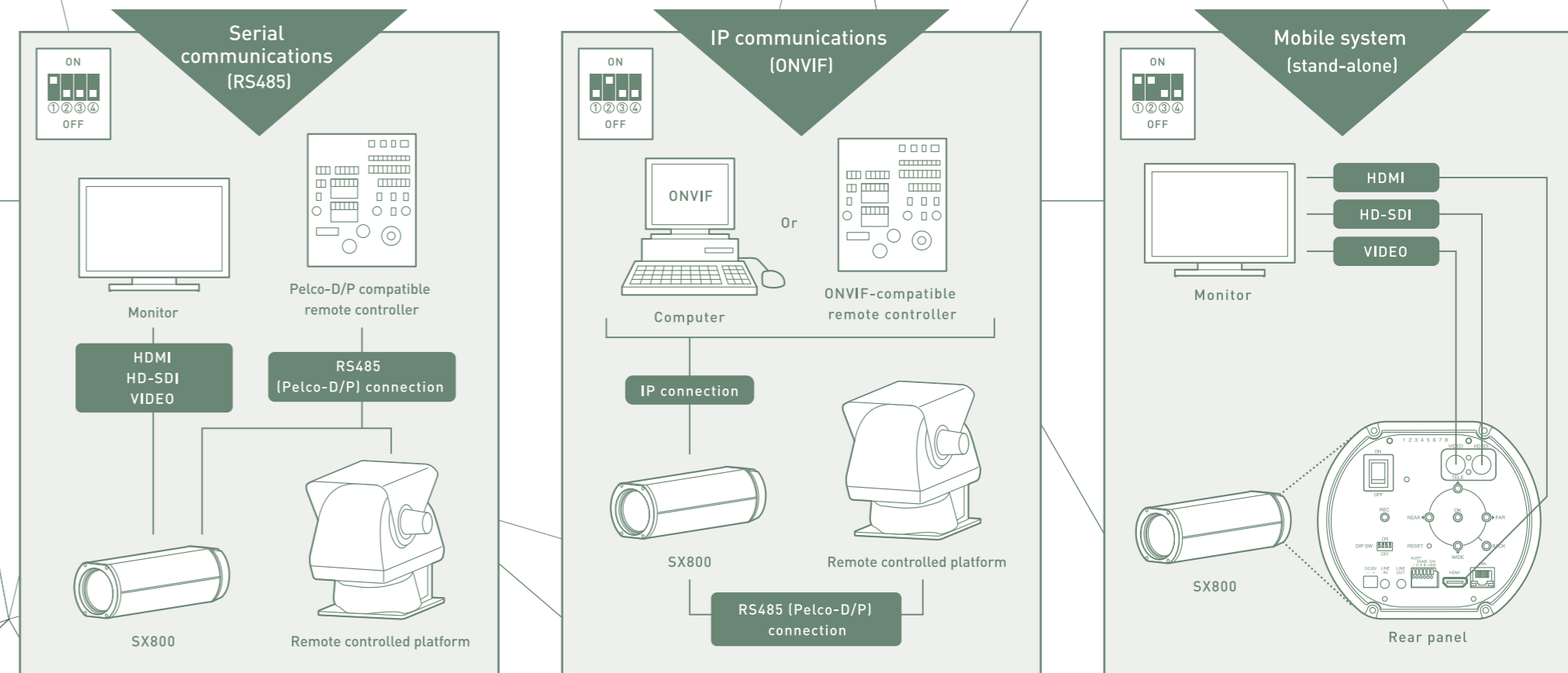

\*Technical information can be downloaded from the website. ▶





## 01 Long-range surveillance

### 40x optical zoom

The SX800 is equipped with a 40x optical zoom lens that covers a broad range of focal lengths from 20mm on the wide angle end to 800mm on the telephoto end. It is complemented up to 2x digital zoom to achieve long-range surveillance equivalent to 1600m in focal length.



20mm

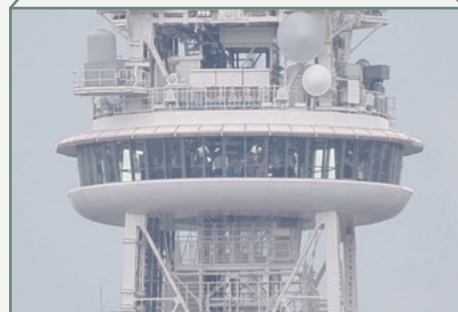

800mm

## 02 High-performance image stabilization

### New image stabilization system

The SX800 combines optical image stabilization (OIS) and electronic image stabilization (EIS) to accurately compensate for camera shake, typically caused by gusts and footing vibrations at the site of camera installation. The system is particularly effective when shooting in the ultra-telephoto range, which is susceptible to even the slightest of shakes.



Without image stabilization

With image stabilization

### Use of new devices

The SX800 sports high-precision gyro sensors to accurately detect minute vibrations that could not be detected previously. The use of newly-developed high-thrust linear motor delivers an advanced level of accuracy and tracking performance.

### High-performance EIS

In the EIS mode, the SX800 uses a sensor large enough for its lens's effective diameter to secure full HD resolution (1920 x 1080), thereby delivering footage of premium quality. The combined use with OIS also improves the durability of the image stabilization system substantially.

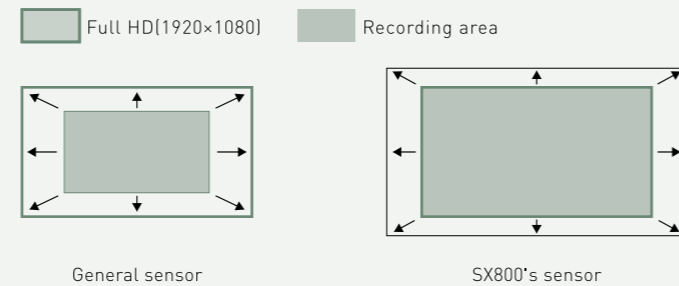

### New ceramic bead roller system

The SX800's OIS uses a unique "ceramic bead roller" system. Ceramic beads, processed in ultimate precision, minimizes friction and resistance to achieve advanced responsiveness and excellent durability in image stabilization.



## 03 High-speed AF system

### On-sensor phase detection AF

The on-sensor phase detection AF uses phase detection pixels across the sensor to instantaneously measure distance according to the displacement of incident lights. The SX800 also offers "contrast AF," which detects areas of high contrast in images at high accuracy, and automatically switches to the optimum AF setting.

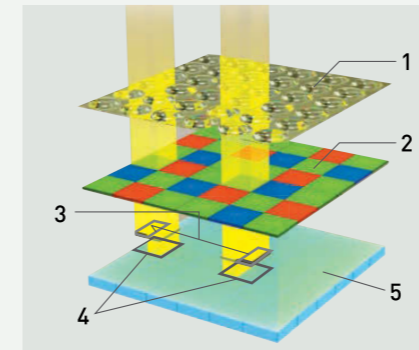

1. Micro lens
2. Color filter
3. Phase detection filter
4. Phase detection pixels
5. Photo diode

### Rear Focus mechanism

The use of the Rear Focus mechanism has significantly reduced the weight of the focusing lens group. This has also dramatically increased the focus drive speed to enable "continuous AF." Users can choose between "Continuous AF," "Quick AF" and "Manual Focus" according to the conditions where the camera is used.

## 04 Image processing technology

### Low light conditions

The use of the highly sensitive sensor and the effect of advanced noise reduction mean the SX800 can shoot clear footage with minimal noise even in low light conditions.

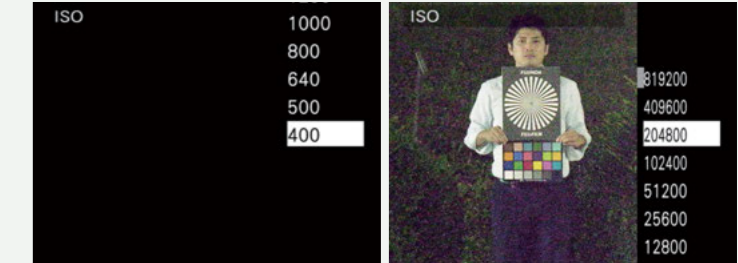

ISO 400

ISO 204800

### Fog reduction

The SX800 uses a unique imaging technology to bring vivid clarity to hazy images caused by light diffusion with airborne mist droplets and dust.



Fog reduction OFF

Fog reduction ON

### Heat haze reduction

The SX800 uses a unique image processing technology to reduce the shimmering effect of heat haze, caused by large difference in atmospheric temperatures, to make the entire images easier to see.

Link to the product introduction video. ▶



## 05 Simplified setup

### Cameras with built-in lens

Conventional surveillance systems require the adjustment of optical axis and flange focal length when mounting a lens on a camera. The SX800, which carries a built-in lens, is shipped with such settings optimally adjusted to bring out maximum performance. The design also eliminates the need for complicated wiring, thereby significantly reducing man-hours at the time of installation.



## 06 Robustness

### New design with advanced rigidity and portability

The SX800's aluminum extrusion body is highly rigid and exceptionally robust. A carrying handle\* may be attached to the body, using screw holes at the top, for transporting convenience.



\* FUJIFILM does not offer a carrying handle.

## Exterior view

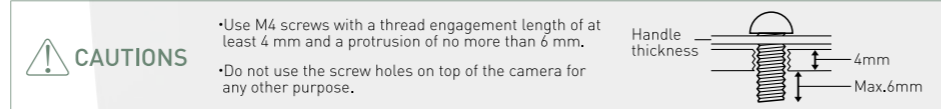
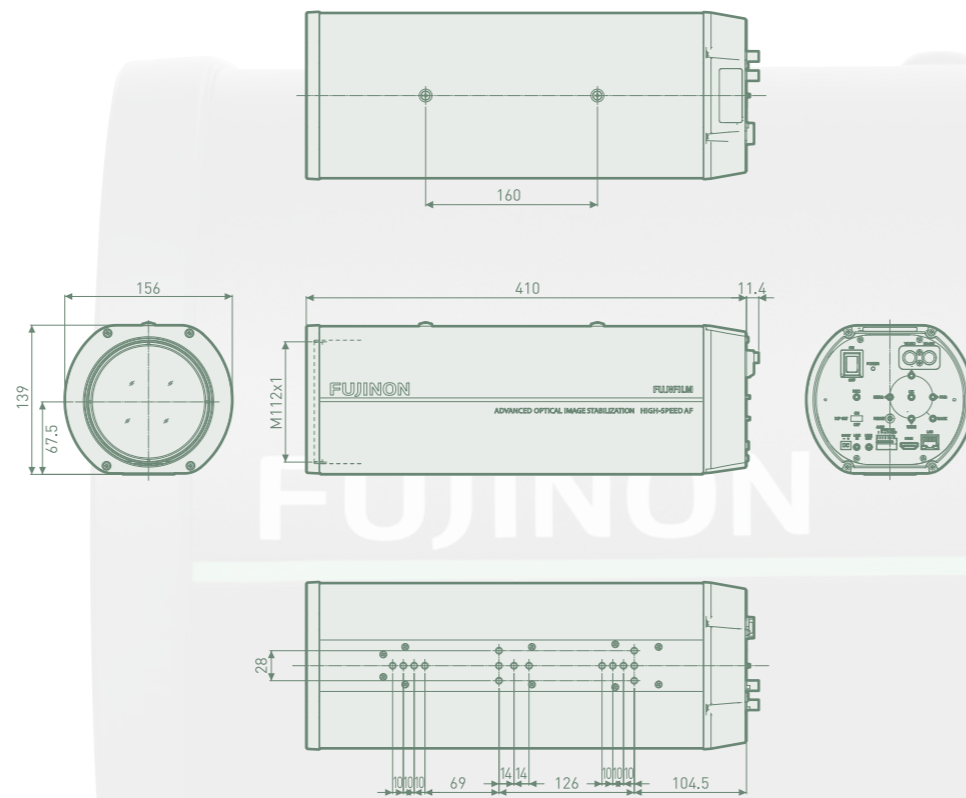

**Screw Hole Specifications** The specifications for the screw holes on the top and base of the camera are as follows:

	Type	Quantity	Depth	Tightening torque
Top	M4	2	Pass through (threaded depth 4 mm)	80-100 N·cm
Base	1/4", UNC 20 thread	15	10 mm	240-300 N·cm

Technical information can be downloaded from the website. ▶



## Main specifications of the long-range surveillance camera, SX800

Lens			
Model name	SX800	Minimum object distance (M.O.D) from the front lens	10m (20 – 400mm in focal length) 20m (401 – 800mm in focal length)
Optical zoom	40x	Angle of view [16:9 (H x V)]	W : 21.0° x 11.8° T : 0.55° x 0.31°
Digital zoom	1.25x, 1.5x, 1.75x, 2x	Maximum aperture ratio	1:4 (W), 1:7.4 (T)
Focal length	20mm – 800mm		

Camera			
Effective sensor size	1/1.8"	Saturation	Selectable (100 levels)
Minimum illumination	Color 0.00015lux (at F1.2) / 0.0017lux (at F4.0) B/W 0.0001lux (at F1.2) / 0.0011lux (at F4.0)	Sharpness	Selectable (100 levels)
Focus settings	Continuous AF, Quick AF, Manual	White balance	AWB, AWB-W, Custom 1 – 2, Fine, Shade, Color Temperature (3000K, 5000K, 9000K)
Iris	Auto, Manual (Aperture range : F4 – F16)	Video output systems	NTSC, PAL
Shutter speed	Auto (with minimum speed selection of 1/8 – 1/125s), Manual (1 – 1/32,000s)	Video format	NTSC: 1080p, 720p, 480p / PAL: 1080p, 720p, 576p
Gain	Manual, AGC, HYPER-AGC (Setting range: ISO400 – 819200)	Video output systems	HDMI, HD-SDI, Composite(BNC)
Optical filter	Visible Light Cut filter (ON / OFF)	Audio input / output	Input impedance: 40kΩ Output impedance: 200Ω
Day / Night selection	Auto, Manual	External interfaces	Ethernet(10Base -T, 100Base-TX, RJ45 connector), RS-485, External trigger (Day / Night)
Wavelengths selection	950nm, 940nm, 850nm, 808nm, Visible light	Recording format	File recording format : MOV Compression format : H.264 compliant Audio recording format : Linear PCM stereo (48kHz sampling)
Image stabilization	Auto, OIS, EIS, OFF	RS-485 compatible protocol	Pelco-D / Pelco-P (including extended commands)
Wide dynamic range	Selectable (2 levels)	Power source	DC12V
Back light correction	Selectable (2 levels)	Power consumption	9.5W
Heat haze reduction	Selectable (3 levels)	Supported SD card (SDHC/SDXC)	UHS-1-compatible 8GB+ SD Speed Class 10 or above
Fog reduction	Selectable (3 levels)		
Noise reduction	Selectable (3 levels)		
Brightness	Selectable (100 levels)		
Contrast	Selectable (100 levels)		

Network	
Network protocols	ICMP, ARP, TCP / IP, UDP / IP, HTTP, RTSP, RTP, DHCP, DNS
Supported OS	Windows 7/10
Supported browser	Chrome71+
ONVIF support	Yes (Profile S)
Maximum number of connections	13 (simultaneously connected users)

Miscellaneous	
Size (H x W x L)	139mm x 156mm x 410mm
Weight	6.4kg
Filter thread size	M112 x 1mm
Operating environment	Temperature : -10°C - +50°C Humidity: 10% – 80% (no condensation)
Tilt limit	45 degrees upward – 45 degrees downward

The product's design, specifications and exterior appearance are subject to change without notice.